



OWNER'S MANUAL

**⚠ Read this manual carefully
before operating this vehicle.**

MT-09

MOTORCYCLE

MTN890R (MT-09)

BME-28199-20

Location of important labels	1
Safety information	2
Description	3
Special features	4
Smartphone Connectivity System	5
Instrument and control functions	6
For your safety – pre-operation checks	7
Operation and important riding points	8
Periodic maintenance and adjustment	9
Motorcycle care and storage	10
Specifications	11
Consumer information	12
Index	13

 **Read this manual carefully before operating this vehicle. This manual should stay with this vehicle if it is sold.**

Use of trade marks

The Bluetooth® word mark and logos are registered trademarks owned by Bluetooth SIG, Inc.

iOS is a registered trademark or trademark of Cisco Systems, Inc. and/or its affiliates in the United States and certain other countries.

Android is a trademark of Google LLC.

Garmin StreetCross™ is a trademark of Garmin Ltd.

Welcome to the Yamaha world of motorcycling!

As the owner of the MTN890R, you are benefiting from Yamaha's vast experience and newest technology regarding the design and manufacture of high-quality products, which have earned Yamaha a reputation for dependability.

Please take the time to read this manual thoroughly, so as to enjoy all advantages of your MTN890R. The Owner's Manual does not only instruct you in how to operate, inspect and maintain your motorcycle, but also in how to safeguard yourself and others from trouble and injury.

In addition, the many tips given in this manual will help keep your motorcycle in the best possible condition. If you have any further questions, do not hesitate to contact your Yamaha dealer.

The Yamaha team wishes you many safe and pleasant rides. So, remember to put safety first!

Yamaha continually seeks advancements in product design and quality. Therefore, while this manual contains the most current product information available at the time of printing, there may be minor discrepancies between your motorcycle and this manual. If there is any question concerning this manual, please consult a Yamaha dealer.







Please read this manual carefully and completely before operating this motorcycle.

Important manual information

EAU10134

Particularly important information is distinguished in this manual by the following notations:

	This is the safety alert symbol. It is used to alert you to potential personal injury hazards. Obey all safety messages that follow this symbol to avoid possible injury or death.
	A WARNING indicates a hazardous situation which, if not avoided, could result in death or serious injury.
	A NOTICE indicates special precautions that must be taken to avoid damage to the vehicle or other property.
	A TIP provides key information to make procedures easier or clearer.

*Product and specifications are subject to change without notice.

EAU10202

**MTN890R
OWNER'S MANUAL
©2024 by Yamaha Motor Co., Ltd.
1st edition, December 2023
All rights reserved.
Any reprinting or unauthorized use
without the written permission of
Yamaha Motor Co., Ltd.
is expressly prohibited.
Printed in Japan.**

Table of contents

Location of important labels	1-1	Shift pedal.....	6-35	Periodic maintenance and adjustment	9-1
Safety information	2-1	Brake lever.....	6-36	Tool kit.....	9-2
Description	3-1	Brake pedal.....	6-37	Periodic maintenance charts.....	9-3
Left view.....	3-1	Brake system.....	6-37	Periodic maintenance chart for the emission control system.....	9-3
Right view.....	3-2	Fuel tank cap.....	6-38	General maintenance and lubrication chart.....	9-5
Controls and instruments.....	3-3	Fuel.....	6-39	Checking the spark plugs.....	9-9
Special features	4-1	Fuel tank overflow hose.....	6-40	Canister.....	9-10
YRC (Yamaha Ride Control).....	4-1	Catalytic converter.....	6-41	Engine oil.....	9-10
Cruise control system.....	4-5	Seats.....	6-41	Why Yamalube.....	9-12
ESS (emergency stop signaling) system.....	4-8	Rider footrest position.....	6-42	Coolant.....	9-13
Smartphone Connectivity		Storage compartment.....	6-43	Air filter element.....	9-14
System	5-1	Handlebar position.....	6-43	Checking the engine idling speed.....	9-14
Smart features: Introduction.....	5-1	Adjusting the front fork.....	6-44	Valve clearance.....	9-15
Initial setup.....	5-3	Adjusting the shock absorber assembly.....	6-46	Tires.....	9-15
Telephone.....	5-7	DC connectors.....	6-48	Cast wheels.....	9-17
Connection troubleshooting.....	5-8	USB Type-C jack.....	6-48	Adjusting the clutch lever free play.....	9-18
Instrument and control functions ...	6-1	Sidestand.....	6-49	Checking the brake lever free play.....	9-19
Immobilizer system.....	6-1	Ignition circuit cut-off system.....	6-49	Brake light switches.....	9-19
Main switch/steering lock.....	6-2	For your safety – pre-operation checks	7-1	Checking the front and rear brake pads.....	9-20
Handlebar switches.....	6-3	Operation and important riding points	8-1	Checking the brake fluid level.....	9-20
Indicator lights and warning lights.....	6-5	Engine break-in.....	8-1	Changing the brake fluid.....	9-22
Display.....	6-8	Starting the engine.....	8-2	Drive chain slack.....	9-22
Menu system.....	6-17	Shifting.....	8-3	Cleaning and lubricating the drive chain.....	9-24
Clutch lever.....	6-35	Tips for reducing fuel consumption.....	8-4		
		Parking.....	8-5		

Table of contents

Checking and lubricating the cables.....	9-25	Specifications	11-1
Checking and lubricating the throttle grip	9-25	Consumer information	12-1
Checking and lubricating the brake and shift pedals	9-25	Identification numbers	12-1
Checking and lubricating the brake and clutch levers.....	9-26	Diagnostic connector.....	12-2
Checking and lubricating the sidestand	9-27	Use of your data	12-3
Lubricating the rear suspension.....	9-27	Motorcycle noise regulation (for Australia)	12-5
Lubricating the swingarm pivots	9-27	Index	13-1
Checking the front fork.....	9-28		
Checking the steering	9-28		
Checking the wheel bearings	9-29		
Battery	9-29		
Replacing the fuses.....	9-30		
Vehicle lights	9-33		
License plate light	9-33		
Supporting the motorcycle.....	9-33		
Troubleshooting	9-34		
Troubleshooting chart	9-35		
Motorcycle care and storage	10-1		
Matte color caution	10-1		
Care	10-1		
Storage.....	10-4		

Location of important labels

EAU10387

1

Read and understand all of the labels on your vehicle. They contain important information for safe and proper operation of your vehicle. Never remove any labels from your vehicle. If a label becomes difficult to read or comes off, a replacement label is available from your Yamaha dealer.

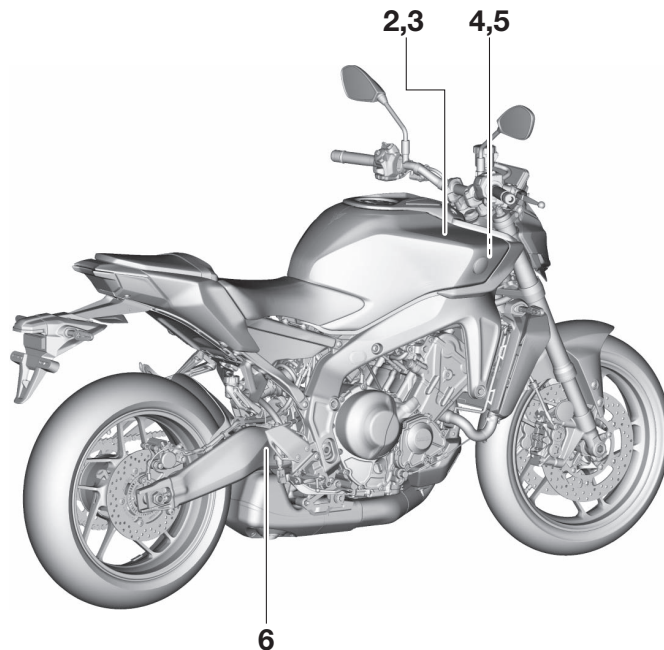

Location of important labels

1



2

⚠ WARNING

- **BEFORE YOU OPERATE THIS VEHICLE, READ THE OWNER'S MANUAL AND ALL LABELS.**
- **ALWAYS WEAR AN APPROVED MOTORCYCLE HELMET**, eye protection, and protective clothing.

1TP-2118K-A2

3

Use PREMIUM unleaded gasoline with min. 95 octane (RON).

2S3-2817K-11

4

STATIONARY NOISE TEST INFORMATION
 TESTED 94 dB(A) AT 5000 r/min
 SILENCING SYSTEM : YAMAHA
 IDENTIFICATION : BME

BME-2118G-10

5

E13

28R-00	6428
39R-01	10184
41R-05	9820
53R-03	0882
78R-05	5361

BME-2811P-00

6

100kPa= 1 bar	kPa,psi	kPa,psi
	250,36	290,42
	250,36	290,42

BM6-21668-01

1

EAU1028C

2

Be a Responsible Owner

As the vehicle's owner, you are responsible for the safe and proper operation of your motorcycle.

Motorcycles are single-track vehicles. Their safe use and operation are dependent upon the use of proper riding techniques as well as the expertise of the operator. Every operator should know the following requirements before riding this motorcycle.

He or she should:

- Obtain thorough instructions from a competent source on all aspects of motorcycle operation.
- Observe the warnings and maintenance requirements in this Owner's Manual.
- Obtain qualified training in safe and proper riding techniques.
- Obtain professional technical service as indicated in this Owner's Manual and/or when made necessary by mechanical conditions.

- Never operate a motorcycle without proper training or instruction. Take a training course. Beginners should receive training from a certified instructor. Contact an authorized motorcycle dealer to find out about the training courses nearest you.

Safe Riding

Perform the pre-operation checks each time you use the vehicle to make sure it is in safe operating condition. Failure to inspect or maintain the vehicle properly increases the possibility of an accident or equipment damage. See page 7-1 for a list of pre-operation checks.

- This motorcycle is designed to carry the operator and a passenger.
- The failure of motorists to detect and recognize motorcycles in traffic is the predominating cause of automobile/motorcycle accidents. Many accidents have been caused by an automobile driver who did not see the motorcycle. Making yourself conspicuous ap-

pears to be very effective in reducing the chance of this type of accident.

Therefore:

- Wear a brightly colored jacket.
- Use extra caution when you are approaching and passing through intersections, since intersections are the most likely places for motorcycle accidents to occur.
- Ride where other motorists can see you. Avoid riding in another motorist's blind spot.
- Never maintain a motorcycle without proper knowledge. Contact an authorized motorcycle dealer to inform you on basic motorcycle maintenance. Certain maintenance can only be carried out by certified staff.

- Many accidents involve inexperienced operators. In fact, many operators who have been involved in accidents do not even have a current motorcycle license.
 - Make sure that you are qualified and that you only lend your motorcycle to other qualified operators.
 - Know your skills and limits. Staying within your limits may help you to avoid an accident.
 - We recommend that you practice riding your motorcycle where there is no traffic until you have become thoroughly familiar with the motorcycle and all of its controls.
- Many accidents have been caused by error of the motorcycle operator. A typical error made by the operator is veering wide on a turn due to excessive speed or undercornering (insufficient lean angle for the speed).
 - Always obey the speed limit and never travel faster than warranted by road and traffic conditions.
- Always signal before turning or changing lanes. Make sure that other motorists can see you.
- The posture of the operator and passenger is important for proper control.
 - The operator should keep both hands on the handlebar and both feet on the operator footrests during operation to maintain control of the motorcycle.
 - The passenger should always hold onto the operator, the seat strap or grab bar, if equipped, with both hands and keep both feet on the passenger footrests. Never carry a passenger unless he or she can firmly place both feet on the passenger footrests.
- Never ride under the influence of alcohol or other drugs.
- This motorcycle is designed for on-road use only. It is not suitable for off-road use.

Protective Apparel

The majority of fatalities from motorcycle accidents are the result of head injuries. The use of a safety helmet is the single most critical factor in the prevention or reduction of head injuries.

- Always wear an approved helmet.
- Wear a face shield or goggles. Wind in your unprotected eyes could contribute to an impairment of vision that could delay seeing a hazard.
- The use of a jacket, heavy boots, trousers, gloves, etc., is effective in preventing or reducing abrasions or lacerations.
- Never wear loose-fitting clothes, otherwise they could catch on the control levers, footrests, or wheels and cause injury or an accident.
- Always wear protective clothing that covers your legs, ankles, and feet. The engine or exhaust system become very hot during or after operation and can cause burns.
- A passenger should also observe the above precautions.

Safety information

2

Avoid Carbon Monoxide Poisoning

All engine exhaust contains carbon monoxide, a deadly gas. Breathing carbon monoxide can cause headaches, dizziness, drowsiness, nausea, confusion, and eventually death.

Carbon Monoxide is a colorless, odorless, tasteless gas which may be present even if you do not see or smell any engine exhaust. Deadly levels of carbon monoxide can collect rapidly and you can quickly be overcome and unable to save yourself. Also, deadly levels of carbon monoxide can linger for hours or days in enclosed or poorly ventilated areas. If you experience any symptoms of carbon monoxide poisoning, leave the area immediately, get fresh air, and **SEEK MEDICAL TREATMENT.**

- Do not run engine indoors. Even if you try to ventilate engine exhaust with fans or open windows and doors, carbon monoxide can rapidly reach dangerous levels.
- Do not run engine in poorly ventilated or partially enclosed areas such as barns, garages, or carports.

- Do not run engine outdoors where engine exhaust can be drawn into a building through openings such as windows and doors.

Loading

Adding accessories or cargo to your motorcycle can adversely affect stability and handling if the weight distribution of the motorcycle is changed. To avoid the possibility of an accident, use extreme caution when adding cargo or accessories to your motorcycle. Use extra care when riding a motorcycle that has added cargo or accessories. Here, along with the information about accessories below, are some general guidelines to follow if loading cargo to your motorcycle:

The total weight of the operator, passenger, accessories and cargo must not exceed the maximum load limit.

Operation of an overloaded vehicle could cause an accident.

Maximum load:
168 kg (372 lb)

When loading within this weight limit, keep the following in mind:

- Cargo and accessory weight should be kept as low and close to the motorcycle as possible. Securely pack your heaviest items as close to the center of the vehicle as possible and make sure to distribute the weight as evenly as possible on both sides of the motorcycle to minimize imbalance or instability.
- Shifting weights can create a sudden imbalance. Make sure that accessories and cargo are securely attached to the motorcycle before riding. Check accessory mounts and cargo restraints frequently.
- Properly adjust the suspension for your load (suspension-adjustable models only), and check the condition and pressure of your tires.
- Never attach any large or heavy items to the handlebar, front fork, or front fender. These items, including such cargo as sleeping bags, duffel bags, or

tents, can create unstable handling or a slow steering response.

- **This vehicle is not designed to pull a trailer or to be attached to a sidecar.**

Genuine Yamaha Accessories

Choosing accessories for your vehicle is an important decision. Genuine Yamaha accessories, which are available only from a Yamaha dealer, have been designed, tested, and approved by Yamaha for use on your vehicle.

Many companies with no connection to Yamaha manufacture parts and accessories or offer other modifications for Yamaha vehicles. Yamaha is not in a position to test the products that these aftermarket companies produce. Therefore, Yamaha can neither endorse nor recommend the use of accessories not sold by Yamaha or modifications not specifically recommended by Yamaha, even if sold and installed by a Yamaha dealer.

Aftermarket Parts, Accessories, and Modifications

While you may find aftermarket products similar in design and quality to genuine Yamaha accessories, recognize that some aftermarket accessories or modifications are not suitable because of potential safety hazards to you or others. Installing aftermarket products or having other modifications performed to your vehicle that change any of the vehicle's design or operation characteristics can put you and others at greater risk of serious injury or death. You are responsible for injuries related to changes in the vehicle.

Keep the following guidelines in mind, as well as those provided under "Loading" when mounting accessories.

- Never install accessories or carry cargo that would impair the performance of your motorcycle. Carefully inspect the accessory before using it to make sure that it does not in any way reduce ground clearance or cornering clearance, limit suspension travel,

steering travel or control operation, or obscure lights or reflectors.

- Accessories fitted to the handlebar or the front fork area can create instability due to improper weight distribution or aerodynamic changes. If accessories are added to the handlebar or front fork area, they must be as lightweight as possible and should be kept to a minimum.
- Bulky or large accessories may seriously affect the stability of the motorcycle due to aerodynamic effects. Wind may attempt to lift the motorcycle, or the motorcycle may become unstable in cross winds. These accessories may also cause instability when passing or being passed by large vehicles.
- Certain accessories can displace the operator from his or her normal riding position. This improper position limits the freedom of movement of the

Safety information

2

operator and may limit control ability, therefore, such accessories are not recommended.

- Use caution when adding electrical accessories. If electrical accessories exceed the capacity of the motorcycle's electrical system, an electric failure could result, which could cause a dangerous loss of lights or engine power.

Aftermarket Tires and Rims

The tires and rims that came with your motorcycle were designed to match the performance capabilities and to provide the best combination of handling, braking, and comfort. Other tires, rims, sizes, and combinations may not be appropriate. See page 9-15 for tire specifications and for information on servicing and replacing your tires.

Transporting the Motorcycle

Be sure to observe following instructions before transporting the motorcycle in another vehicle.

- Remove all loose items from the motorcycle.
- Check that the fuel cock (if equipped) is in the off position and that there are no fuel leaks.
- Shift the transmission into gear (for models with a manual transmission).
- Secure the motorcycle with tie-downs or suitable straps that are attached to solid parts of the motorcycle, such as the frame or upper front fork triple clamp (and not, for example, to rubber-mounted handlebars or turn signals, or parts that could break). Choose the location for the straps carefully so the straps will not rub against painted surfaces during transport.
- The suspension should be compressed somewhat by the tie-downs, if possible, so that the motorcycle will not bounce excessively during transport.

Left view

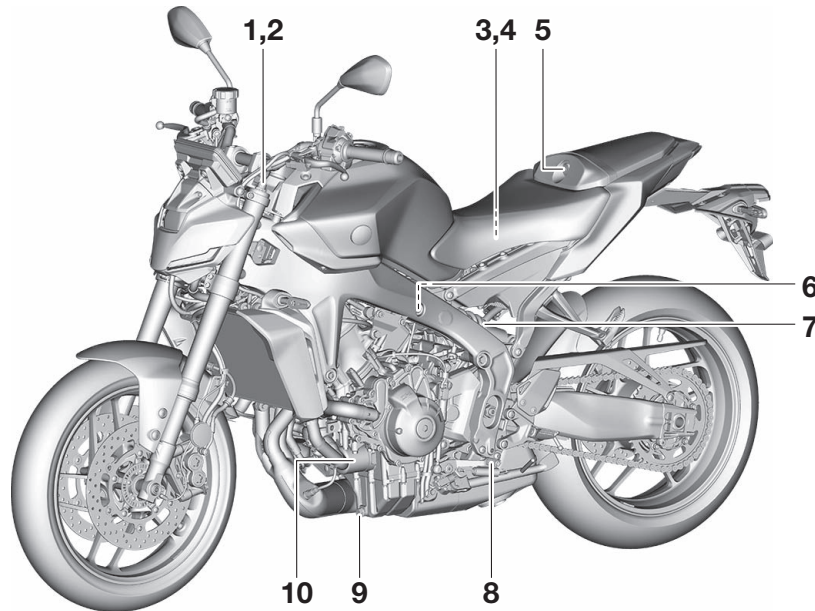

1. Spring preload adjuster (page 6-44)
2. Compression damping force adjuster (page 6-44)
3. Battery (page 9-29)
4. USB Type-C jack (page 6-48)
5. Seat lock (page 6-41)
6. Rebound damping force adjuster (page 6-46)
7. Spring preload adjuster (page 6-46)
8. Shift pedal (page 6-35)

9. Engine oil drain bolt (page 9-10)
10. Oil filter cartridge (page 9-10)

Description

EAU10421

Right view

3

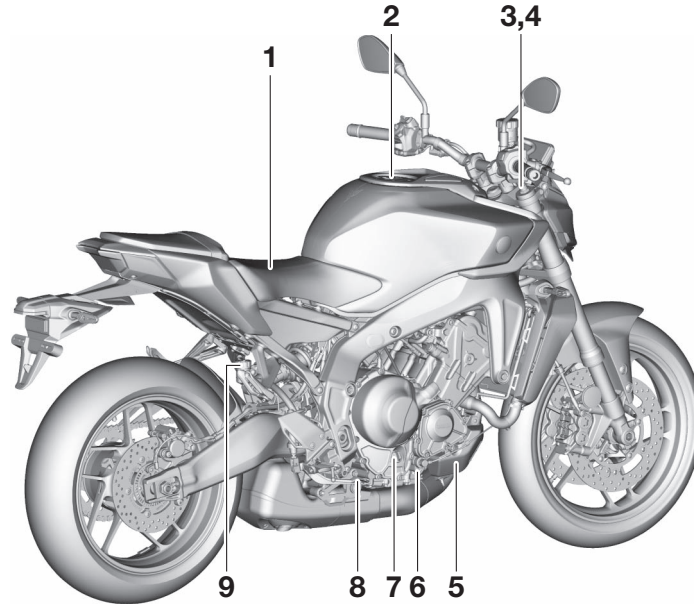

1. Fuses (page 9-30)
2. Fuel tank cap (page 6-38)
3. Spring preload adjuster (page 6-44)
4. Rebound damping force adjuster (page 6-44)
5. Coolant reservoir (page 9-13)
6. Engine oil level check window (page 9-10)
7. Engine oil filler cap (page 9-10)
8. Brake pedal (page 6-37)
9. Rear brake fluid reservoir (page 9-20)

Controls and instruments

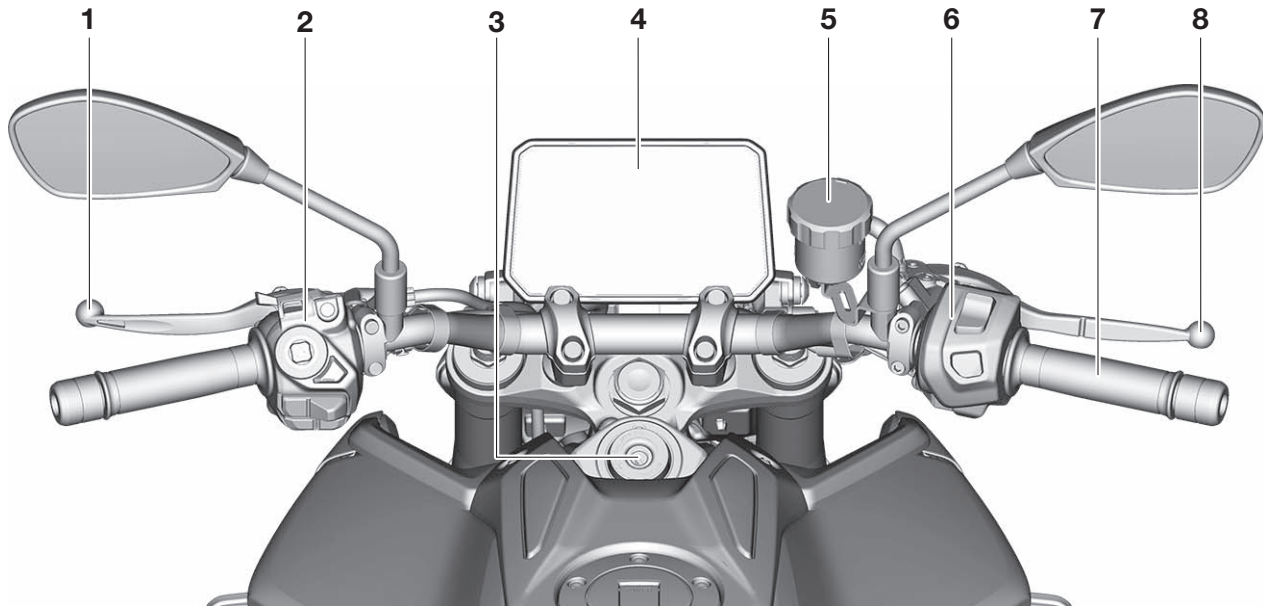

1. Clutch lever (page 6-35)
2. Left handlebar switches (page 6-3)
3. Main switch/steering lock (page 6-2)
4. Multi-function meter unit (page 6-5)
5. Front brake fluid reservoir (page 9-20)
6. Right handlebar switches (page 6-3)
7. Throttle grip (page 9-25)
8. Brake lever (page 6-36)

Special features

4

YRC (Yamaha Ride Control)

EUA2482

YRC is a system that incorporates numerous sensors and controls to support an improved riding experience. The vehicle senses and can react to forces along the longitudinal (front-to-back), lateral (left-to-right), and vertical (up-and-down) axes. Lean angle and G-force accelerations are also detected. This information is processed multiple times a second and the related physical systems are automatically adjusted as necessary. The following functions represent individual YRC items which can be turned on/off or adjusted to suit various riders and riding conditions. For setting details, see page 6-27.

EWA18221

WARNING

The Yamaha Ride Control (YRC) system is not a substitute for the use of proper riding techniques or the expertise of the operator. This system cannot prevent loss of control caused by rider errors such as traveling faster than warranted by road and traffic conditions, including loss

of traction due to excessive speed when entering turns, when accelerating hard at a sharp lean angle, or while braking, and it cannot prevent front wheel slip or front wheel lift. As with any motorcycle, always ride within in your limits, be aware of surrounding conditions, and ride appropriately for those conditions. Become thoroughly familiar with the way the motorcycle handles with various YRC settings before attempting more advanced maneuvers.

SC (Stability control system)

SC consists of TCS (traction control system), SCS (slide control system), LIF (lift control system) and BSR (back slip regulator). These can be independently adjusted in the menu system (see page 6-27), or turned on/off all together by turning off TCS in the menu system (see page 6-30).

When any of the SC systems engage while riding, the stability control indicator light “

PWR (Power delivery mode)

PWR consists of four different control maps which regulate throttle valve opening in relation to the degree of throttle grip operation, thus providing you with a selection of modes to fit your preferences and the riding environment.

Level 1 - Sporty engine response.

Level 2 - Moderate engine response.

Level 3 - Mild engine response.

Level 4 - Rainy days or whenever less engine power is desirable.

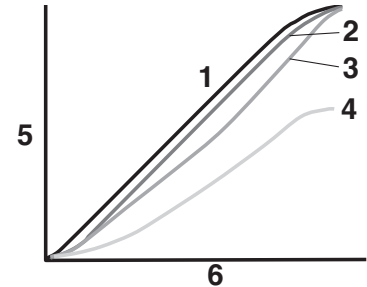

1. Level 1
2. Level 2
3. Level 3
4. Level 4
5. Throttle valve opening
6. Throttle grip operation

TCS (Traction control system)

TCS helps maintain traction when accelerating. If sensors detect that the rear wheel is starting to slip (uncontrolled spinning), TCS assists by regulating engine power as needed until traction is restored.

TCS automatically adjusts according to the vehicle's lean angle. To maximize acceleration, when the vehicle is upright a less amount of traction control is applied. When cornering, a greater amount of traction control is applied.

TCS has multiple setting levels. The higher the setting level, the greater the amount of system intervention.

Level 1 - Suitable for more sporty riding.

Level 2 - Suitable for street riding.

Level 3 - Suitable for riding on wet or slippery surfaces.



Traction control system

TIP

- TCS may engage when the vehicle travels over a bump.
- You may notice slight changes in engine and exhaust sounds when TCS or other YRC systems engage.
- When the main switch is turned on, TCS automatically turns on. TCS can be turned on/off manually only when the main switch is turned on and the vehicle is stopped.
- Turn TCS off to help free the rear wheel if the vehicle gets stuck in mud, sand, or other soft surfaces.

⚠ WARNING

The traction control system is not a substitute for riding appropriately for the conditions. Traction control cannot prevent loss of traction due to excessive speed when entering turns, when accelerating hard at a sharp lean angle, or while braking, and cannot prevent front wheel slipping. As with any vehicle, approach surfaces that may be slippery with caution and avoid especially slippery surfaces.

ECA16801

NOTICE

Use only the specified tires. (See page 9-15.) Using different sized tires will prevent the traction control system from controlling tire rotation accurately.

SCS (Slide control system)

SCS regulates engine power output when a sideward slide is detected in the rear wheel. It adjusts power output based on the lean angle of the vehicle.

Special features

4

This system supports TCS (traction control system) to contribute to a smoother ride.

SCS has multiple setting levels. The higher the setting level, the greater the amount of system intervention to strongly reduce lateral wheel slippage. Level 1 - Suitable for more sporty riding.

Level 2 - Suitable for street riding.

Level 3 - Suitable for riding on wet or slippery surfaces.

LIF (Lift control system)

LIF reduces the rate at which the front wheel will continue to rise during extreme acceleration, such as during starts or out-of-corner exits. When front-wheel lift is detected, engine power is regulated to slow front-wheel lift while still providing good acceleration.

LIF can be set to 1, 2, and 3.

The higher the setting level, the greater the amount of system intervention to reduce wheel lift.

Level 1 - Least lift control. Suitable for more sporty riding.

Level 2 - More lift control. Suitable for sporty riding.

Level 3 - Most lift control. Suitable for street riding.

QS (Quick shifter)

QS allows for clutch lever-less, electronically-assisted shifting. When the sensor on the shift rod detects the appropriate motion in the shift pedal, engine power output is momentarily adjusted to allow for the gear change to occur.

QS does not operate when the clutch lever is pulled, therefore normal shifting can be done even when QS is set to on. Check the quick shifter indicator for current status and usability information.

Quick shifter usability	Indicator
Upshifting OK	QS ▲▼
Downshifting OK	QS ▲▼
Quick shifter cannot be used	QS ▲▼
Quick shifter turned off	QS ▲▼

Upshifting conditions

- Vehicle speed of at least 15 km/h (9 mi/h)
- Engine speed of at least 2000 r/min
- Engine speed sufficiently below the red zone

Downshifting conditions

- Vehicle speed of at least 15 km/h (9 mi/h)
- Engine speed of at least 1600 r/min
- Engine speed sufficiently away from red zone

TIP

- “QS ▲” and “QS ▼” can be individually set.
- Shifting into or out of neutral must be done using the clutch lever.

BC (Brake control system)

BC regulates hydraulic brake pressure for the front and rear wheels when the brakes are applied. This system has two settings:

- OFF: Only the standard ABS (anti-lock brake system) , which adjusts brake pressure based on vehicle speed and wheel speed data. The standard ABS (anti-lock brake system) designed to engage and maximize braking when the vehicle is upright.
- ON: ABS (Anti-lock brake system) and cornering assist braking are both active. In addition to the standard ABS, it suppresses the increase in brake pressure when unavoidable abrupt braking occurs during cornering, making the vehicle's recovery to upright position more gradual. Also, additional data from the IMU regulates applied brake power depending on lean angle in order to increase the feeling of stability and to suppress wheel lock.

See page 6-37 for more information on the Brake System.

TIP

For skilled riders or when track riding, a variety of conditions may cause BC to brake faster than expected for a desired cornering speed or intended cornering line.

WARNING

- **Even with BC ON, strong braking during cornering may result in wheel slippage and loss of balance. Please decelerate sufficiently before entering corners.**
- **Do not use BC on roads other than public roads, as BC may not operate properly and an accident may result.**

BSR (Back slip regulator)

BSR helps maintain traction when decelerating and/or downshifting in low traction conditions. If sensors detect that the rear wheel is starting to slip or lock, BSR assists by regulating engine power as needed until traction is restored.

TIP

- BSR may engage when the vehicle travels over a bump.
- You may notice slight changes in engine and exhaust sounds when BSR or other YRC systems engage.
- For skilled riders or those engaging in track riding, various conditions may lead BSR to influence the vehicle's behavior differently from what the rider anticipates.

WARNING

The back slip regulator is not a substitute for riding appropriately for the conditions. The back slip regulator cannot prevent loss of traction due to excessive speed when entering turns or braking and cannot prevent front wheel slippage. As with any vehicle, approach surfaces that may be slippery with caution and avoid especially slippery surfaces.

EWA22532

EWA22700

Special features

ECA28580

EUA2493

NOTICE

Use only the specified tires. (See page 9-15.) Using different sized tires will prevent the back slip regulator from controlling tire rotation accurately.

4

Cruise control system

This model is equipped with a cruise control system designed to maintain a set cruising speed.

The cruise control system operates only when riding in 3rd gear or higher, at speeds between about 40 km/h (25 mi/h) and 180 km/h (110 mi/h).

EWA20950

WARNING

- **Improper use of the cruise control system may result in loss of control, which could lead to an accident. Do not activate the cruise control system in heavy traffic, poor weather conditions, or among winding, slippery, hilly, rough or gravel roads.**
- **When traveling uphill or downhill, the cruise control system may not be able to maintain the set cruising speed.**
- **To prevent accidentally activating the cruise control system, turn it off when not in use. Make sure that the cruise control system indicator “A close-up photograph of the motorcycle handlebar controls. Two callout numbers are present: '1' points to a circular power button with a power symbol, and '2' points to a rectangular switch with 'RES/+/' and 'SET/-' markings.**

1. Cruise control power button “

Activating the cruise control system

1. Press the cruise control power button “

4-5

speed indicator “0_{km/h}”. The cruise control indicator “” will also turn green.

TIP

If the cruise control indicator “” comes on in amber, have a Yamaha dealer inspect the vehicle.

Adjusting the set cruising speed

While the cruise control system is active, press the “RES/+” side of the cruise control setting switch to increase the set cruising speed or the “SET/-” side to decrease the set speed. Both the vehicle speed and the speed shown in the set speed indicator “0_{km/h}” will change accordingly.

TIP

Pressing the setting switch once will change the set speed in increments of 1.0 km/h (1.0 mi/h). Hold down the “RES/+” or “SET/-” side of the cruise control setting switch to increase or decrease the speed continuously until the switch is released.

You can also manually increase your traveling speed using the throttle. After you have accelerated, you can set a new cruising speed by pressing the “SET/-” side of the setting switch. If you do not set a new cruising speed, when you return the throttle grip, the vehicle will decelerate to the previously set cruising speed.

Deactivating the cruise control system

Perform any of the following actions to deactivate the cruise control system and place it on standby. When the system enters standby, both the cruise control indicator “” and the set speed indicator “0_{km/h}” will lose green status.

- Turn the throttle grip past the fully closed position in the deceleration direction.

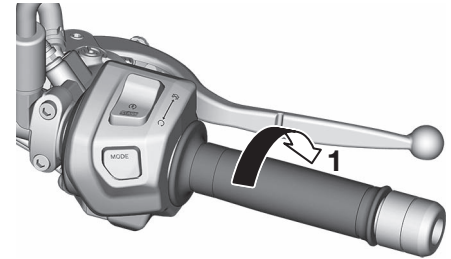

1. Deceleration direction

- Apply the front or rear brake.
- Disengage the clutch.
- Shift gears.

TIP

Traveling speed decreases as soon as the cruise control system is deactivated; unless the throttle grip is turned.

Using the resume function

Press the “RES/+” side of the cruise control setting switch to reactivate the cruise control system from standby. The traveling speed will return to the previous set cruising speed. Both the cruise control indicator “” and the set speed indicator “0_{km/h}” will turn green.

Special features



EWA16351

WARNING

It is dangerous to use the resume function when the previously set cruising speed is too high for current conditions.

4

Turning off the cruise control system



At any time, press the cruise control power button “ /  / 



TIP

Whenever the cruise control system or the vehicle power is turned off, the previously set cruising speed is erased. You will not be able to use the resume function until a new cruising speed has been set.

Automatic deactivation of the cruise control system

The cruise control system is electronically controlled and linked with other control systems. The cruise control system will automatically deactivate under the following conditions:

- The cruise control system is not able to maintain the set cruising speed (such as when going up a steep hill).
- Wheel slip or wheel spin is detected. (If the traction control system is on, traction control will engage.)
- Stop/Run/Start switch “ /  / 

If the cruise control system turns off under the above conditions, the cruise control indicator “ / 

When traveling uphill or downhill, the cruise control system may, in some cases, fail to maintain the set cruising speed.

- When the vehicle is traveling uphill, the actual traveling speed may become lower than the set cruising speed. If this occurs, accelerate to the desired traveling speed using the throttle.
- When the vehicle is traveling downhill, the actual traveling speed may become higher than the set cruising speed. If this occurs, the setting switch cannot be used to adjust the set cruising speed. To reduce the traveling speed, apply the brakes. When the brakes are applied, the cruise control system will become deactivated.

ESS (emergency stop signaling) system EAU1773

When sudden deceleration occurs this system automatically activates to cause all turn signal lights to flash rapidly.

This provides additional warning to surrounding vehicles that your vehicle is decelerating rapidly.

The ESS system then deactivates under the following conditions:

- When the brakes are released.
- When sudden deceleration is no longer detected.

EWA22680

WARNING

The ESS system is not a collision prevention system. Avoid unnecessary hard braking and prioritize safe driving.

TIP

- The ESS system only activates when it detects sudden braking while the vehicle is traveling at speeds of 50 km/h (31 mi/h) or higher.

- ESS does not activate when the hazard lights are already activated.
- If the ESS is activated while one of the turn signal lights is already flashing, the ESS takes priority, causing all turn signals to flash rapidly.
- ESS does not operate when the ABS indicator light is on.

Smartphone Connectivity System

Smart features: Introduction

EUA1871

EWA21412

WARNING

- Failure to pay attention while riding could result in death or serious injury. Always concentrate on riding by keeping your eyes and mind on the road.
- Stop the vehicle before making any settings changes.
- Changing settings while riding can distract the operator and increase the risk of an accident.
- Never take your hands off the handlebars while riding.
- Keep volume levels low enough to maintain awareness of your surroundings and ensure safety.

This vehicle is equipped with an extensive suite of smart features utilizing your smartphone, connected to the vehicle through a communication control unit (CCU) and the Yamaha Motorcycle Connect app on your phone.

- GPS navigation (requires Garmin StreetCross) (page 5-5)
- Telephone (page 5-7)

- Audio player (page 6-34)
- Smartphone notifications (page 6-22)
- Weather information (page 6-21)
- Clock automatic update (page 6-30)
- Language settings (page 5-2)

TIP

- Some features may not be available depending on your smartphone. Some music and SNS applications may not function properly in combination with other applications.
- The CCU takes approximately 10 seconds to initiate its Bluetooth function after the vehicle power is turned on. Related functions will be grayed out in the menu system during this time.



Smart features are accessed via the menu system on the main display (page 6-17). The menu system and all related features are controlled using the joystick/“✓” and the home button “↵” (page 6-5).

First, please read how to operate the basic menu controls in the next section, and then an initial setup and connection of a smartphone must be completed.

Menu system controls

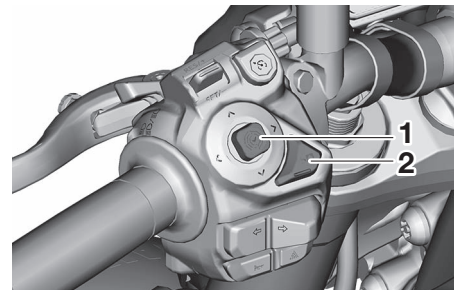

1. Joystick “✓”
2. Home button “↵”

This manual uses the following terms to describe the usage of the menu controls:



Smartphone Connectivity System

Short press	Briefly press the joystick or button
Long press	Press the joystick or button for 1 second

To open the pop-up menu from the main display:

Short press the home button “”

Menu system operation:

- Operate the joystick left-right-up-down to highlight and adjust menu items.
- Short press “” to select an item.
- Short press the home button “” to cancel/return to previous.
- Long press the home button “” to close the menu system.

TIP

When the navigation system is not connected, the navigation home display cannot be cycled to using the home button “”.

Yamaha Motorcycle Connect app



Yamaha Motorcycle Connect is a free app which is needed to complete the connection between the CCU and your smartphone. The app can be searched by name and downloaded from your smartphone application store.

TIP

- Use of Yamaha Motorcycle Connect is subject to your agreement to the Yamaha Motorcycle Connect terms of use.
- The Yamaha Motorcycle Connect app may not function on all smartphones or OS (operating system) versions.

- Navigation and other features require GPS access permissions to be set as “Always allow” on your smartphone.
- Every smartphone operates differently; refer to your individual device instructions regarding connectivity, Bluetooth discovery, app permissions, and other settings.

Smartphone Connectivity System

EAU1882

Initial setup

This section describes the basic setup procedures to connect your smartphone to the CCU and start using smart features.

1. Download/install the Yamaha Motorcycle Connect app on your smartphone via an application store. Complete the installation and pair/connect it to the CCU via Bluetooth.



2. To use the navigation system, download/install the Garmin StreetCross app. Complete the installation and pair/connect it to the CCU via Bluetooth.



3. To use the audio/phone/navigation system route guidance, pair/connect a Bluetooth headset to your smartphone. (See page 5-6.)

Yamaha Motorcycle Connect pairing



ECAN0150

NOTICE

The Bluetooth connection may not work in the following situations.

- In a location exposed to strong radio waves or other electromagnetic noise.

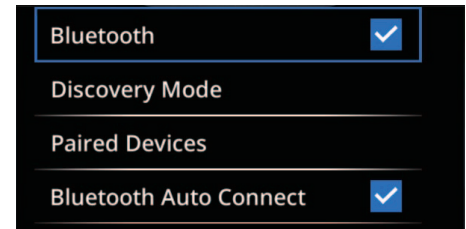
- At facilities nearby that are emitting strong radio waves (TV or radio towers, power plants, broadcasting stations, airports, etc.).

1. Download and install the Yamaha Motorcycle Connect app on your smartphone.
2. Short press the home button “

3. Make sure there is a blue checkmark next to “Bluetooth” and select “Discovery Mode”.

Smartphone Connectivity System

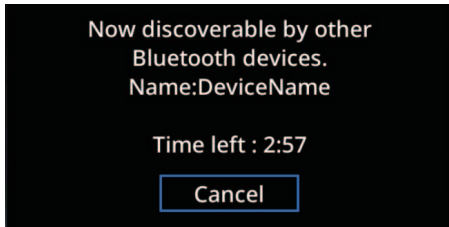

4. Open the Yamaha Motorcycle Connect app and navigate to the pairing display. Follow the instructions on the app to detect the CCU and pair/connect with it.

TIP

After making the CCU discoverable, a pairing must be completed within 3 minutes or the process will fail. If a failure occurs, select "Discovery Mode" again to retry.

5. A request for Bluetooth pairing will appear with a passkey matching the one displayed on the smartphone. Operate the joystick to highlight "Yes" and then short press "✓".

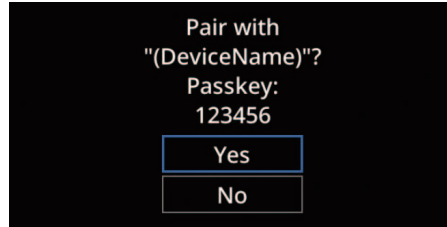

6. Accept the pairing request on your smartphone.

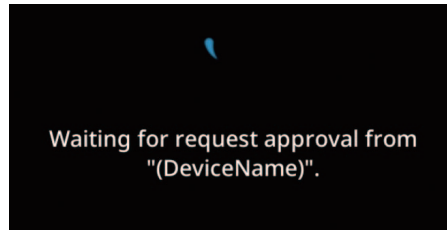

TIP

- After the passkey appears, the pairing must be confirmed within 30 seconds or it will time out. If a failure occurs, select "Discovery Mode" again to retry.

- When connected, the Yamaha Motorcycle Connect indicator "App" will appear on the top of the main display and also next to the connected smartphone device name in the "Paired Devices" list. (See page 6-23.)

TIP

- A request will appear on your smartphone to share contact information with the vehicle. If you decline to upload the data to the CCU and/or allow access to notifications, you can do so later in your smartphone's settings.
- If a Bluetooth pairing record is deleted from the smartphone, then the corresponding pairing record must be deleted from the "Paired Devices" list in order to pair again successfully.
- If a Bluetooth pairing record is deleted from the "Paired Devices" list, then the corresponding pairing record must be deleted from the smartphone in order to pair again successfully.

Smartphone Connectivity System

5

- The first time the vehicle is paired with the Yamaha Motorcycle Connect app, the menu system language will change to match the language selected in the app. When first installed, the app adopts the system language of the smartphone. If the language is not supported by the CCU, then English will be automatically selected.
- Once paired, the Yamaha Motorcycle Connect app will open automatically when a Bluetooth connection is established and will connect to the CCU automatically (This functionality varies by smartphone and/or OS versions. Refer to the Yamaha Motorcycle Connect app for more details).

Navigation system: Garmin StreetCross

EWA21401

WARNING

- **Always stop the vehicle before operating the navigation system.**

- **Always concentrate on riding by keeping your eyes and mind on the road.**



This vehicle is equipped with a navigation system which provides visual and audio route guidance. To use the navigation system, you must first download the Garmin StreetCross app from an application store on a smartphone and then register for its service.

See page 6-16 for more information about operating the navigation system.

TIP

- Use of the Garmin StreetCross app is subject to your agreement to the Garmin StreetCross terms of use.

- Yamaha shall not be liable for any damages resulting from the use of the Garmin StreetCross app.
- The smartphone must remain unlocked and the Garmin StreetCross app must be kept in the foreground in order to ensure the smartphone does not sleep (lock). If another app's function moves the Garmin StreetCross app to the background (phone call, alarm, etc.) the smartphone may sleep (lock) and the navigation may stop.
- The Garmin StreetCross app's GPS access permissions must be set to "Always allow" on your smartphone's settings.
- The Garmin StreetCross app may not work on all smartphones or OS (operating system) versions.
- While route guidance is active, the weather information at the destination will be displayed. If the destination is more than 1 hour away, the weather information will be from a location 1 hour away on route to the destination.

Garmin StreetCross pairing

ECAN0150

NOTICE

The Bluetooth connection may not work in the following situations.

- In a location exposed to strong radio waves or other electro-magnetic noise.
- At facilities nearby that are emitting strong radio waves (TV or radio towers, power plants, broadcasting stations, airports, etc.).

1. Download and install the Garmin StreetCross app on your smartphone.
2. Open the Garmin StreetCross app and tap “A screenshot of the Garmin StreetCross app interface. At the top, it displays weather information: a sun icon, 30°C, and 4pm. Below this is a 'Current Location' label. The main area is a map with a blue line indicating a route. A blue circular icon with the number '65' is visible on the map. In the top right corner, there are two circular icons: one with a Bluetooth symbol and another with a gear (settings).

TIP

When connected, the navigation connection indicator “

Bluetooth headset pairing

Follow your headsets manufacturer instructions to pair/connect to your smartphone. When the headset connection is detected by the Yamaha Motorcycle Connect app, the headset indicator “

TIP

When the using headset voice function, the Bluetooth connection between the smartphone and the CCU may become unstable. See the Yamaha Motorcycle Connect app for more details.

Smartphone Connectivity System

EAU11890

Telephone

This vehicle is equipped with a telephone function that requires both a smartphone and a Bluetooth headset. The smartphone must be paired and connected to both the CCU and a Bluetooth headset (page 5-3).

5

Receiving phone calls:



When a phone call is received to a connected smartphone, the ringtone will play through the connected headset and a telephone function will appear at the bottom of the display. Highlight the green phone icon and short press “✓” to answer the call. The active phone call indicator icon “☎” will appear for the duration of the call.

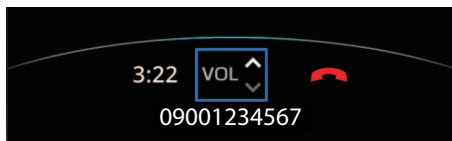

Highlight the volume icon and operate the joystick up-down to adjust the call volume. Highlight the end call icon and short press “✓” to hang up the call.

TIP

- For some smartphone models, the call volume cannot be adjusted using the handlebar switches. In this case, the volume adjustment will be grayed out on the active call display.
- When a phone call is active and a second incoming call is accepted, the first call will be put on-hold until the second call is ended.
- For some smartphones, when a call is active and a second incoming call is rejected, the displayed caller ID might change to the second caller ID.
- For some smartphones, rejecting a call with the joystick / “✓” will not function correctly. The end call icon may be grayed out or using the end call icon will accept the call instead. In this case, operate the smartphone directly to end the call.

Making phone calls:

To make a phone call, you must start the phone call directly on your smartphone. Once active, the active call display will be accessible under “☎ Phone” in the menu system (page 6-33) and the active call indicator will appear at the top of the main display (page 6-13). The call audio will play through the connected Bluetooth headset.

EWA21420

! WARNING

- **Do not use your smartphone while the vehicle is in motion.**
- **Never take your hands off the handlebars while riding.**
- **Always concentrate on riding by keeping your eyes and mind on the road.**
- **Keep volume levels low enough to maintain awareness of your surroundings and ensure safety.**

Connection troubleshooting EAU99213

If a connection error occurs between the smartphone, Yamaha Motorcycle Connect app, Garmin StreetCross app and/or CCU, the following screen is displayed.

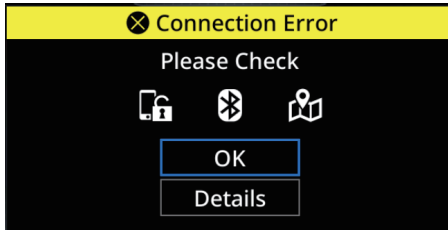

Select “Details” and check the connection as instructed on the screen.

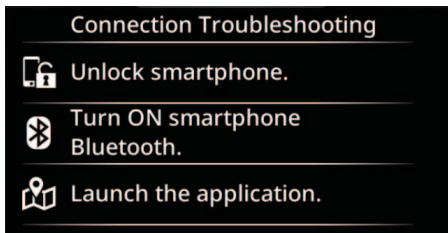

If the error persists, try the following:

1. Turn OFF the vehicle power. After 20 seconds, turn ON the vehicle power again.
2. Turn OFF the smartphone's Bluetooth. Then turn it ON again.
3. Delete Bluetooth pairing information from both smartphone and vehicle.
4. Reboot the Yamaha Motorcycle Connect app and Garmin StreetCross app.

Instrument and control functions

Immobilizer system

EAU1097B

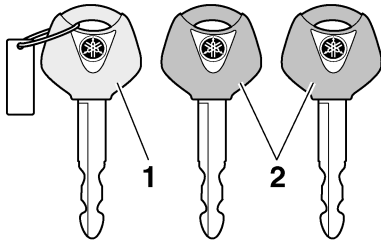

6

1. Code re-registering key (red bow)
2. Standard keys (black bow)

This vehicle is equipped with an immobilizer system to help prevent theft by re-registering codes in the standard keys. This system consists of the following:

- a code re-registering key
- two standard keys
- a transponder (in each key)
- an immobilizer unit (on the vehicle)
- an ECU (on the vehicle)
- a system indicator light (page 6-6)

About the keys

The code re-registering key is used to register codes in each standard key. Store the code re-registering key in a safe place. Use a standard key for daily operation.

When key replacement or re-registering is necessary, bring the vehicle and the code re-registering key along with any remaining standard keys to a Yamaha dealer to have them re-registered.

TIP

- Keep the standard keys as well as keys of other immobilizer systems away from the code re-registering key.
- Keep other immobilizer system keys away from the main switch as they may cause signal interference.

ECA11823

NOTICE

DO NOT LOSE THE CODE RE-REGISTERING KEY! CONTACT YOUR DEALER IMMEDIATELY IF IT IS LOST! If the code re-registering key is lost, the existing standard keys

can still be used to start the vehicle. However, registering a new standard key is impossible. If all keys have been lost or damaged, the entire immobilizer system must be replaced. Therefore, handle the keys carefully.

- Do not submerge in water.
- Do not expose to high temperatures.
- Do not place near magnets.
- Do not place near items that transmit electrical signals.
- Do not handle roughly.
- Do not grind or alter.
- Do not disassemble.
- Do not put two keys of any immobilizer system on the same key ring.

Main switch/steering lock

EAU10474

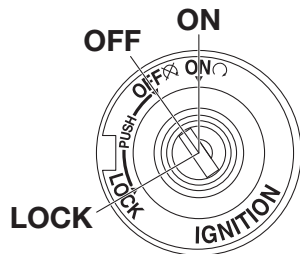

The main switch/steering lock controls the ignition and lighting systems, and is used to lock the steering. The various positions are described below.

TIP

Be sure to use the standard key (black bow) for regular use of the vehicle. To minimize the risk of losing the code re-registering key (red bow), keep it in a safe place and only use it for code re-registering.

ON

All electrical circuits are supplied with power and the vehicle lights are turned on. The engine can be started. The key cannot be removed.

TIP

- The headlight(s) will turn on when the engine is started.
- To prevent battery drain, do not leave the key in the "ON" position without the engine running.

OFF

All electrical systems are off. The key can be removed.

⚠ WARNING

Never turn the key to "OFF" or "LOCK" while the vehicle is moving. Otherwise the electrical systems will be switched off, which may result in loss of control or an accident.

LOCK

The steering is locked and all electrical systems are off. The key can be removed.

To lock the steering

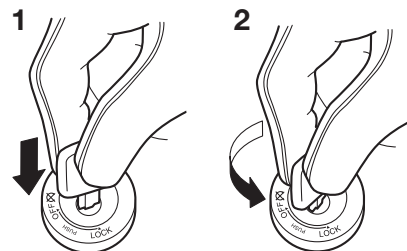

1. Push.
2. Turn.

1. Turn the handlebars all the way to the left.
2. With the key in the "OFF" position, push the key in and turn it to "LOCK".
3. Remove the key.

Instrument and control functions

TIP _____
 If the steering will not lock, try turning the handlebars back to the right slightly.

To unlock the steering

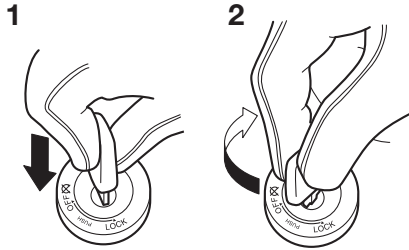

1. Push.
2. Turn.

Push the key in and turn it to "OFF".

Handlebar switches

EAU6605A

Left

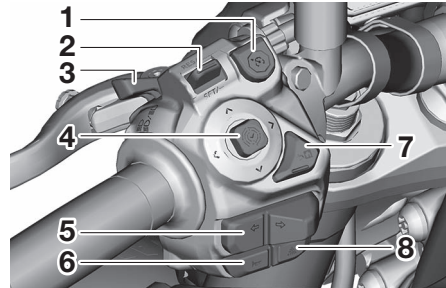

1. Cruise control power button "⊞"
2. Cruise control setting switch "RES/+ / SET/-"
3. Dimmer/Pass switch "☰/☲"
4. Joystick "✓"
5. Turn signal switch "←/→"
6. Horn switch "🔊"
7. Home button "🏠"
8. Hazard switch "⚠️"

Right

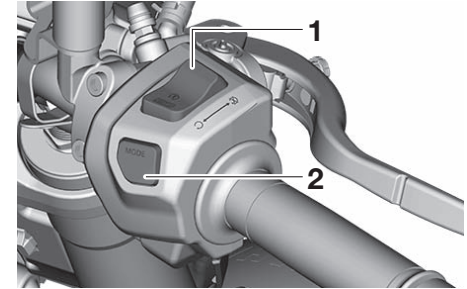

1. Stop/Run/Start switch "⊞/⊚/⊚"
2. YRC mode button "MODE"

Dimmer/Pass switch "☰/☲"

EAU1904

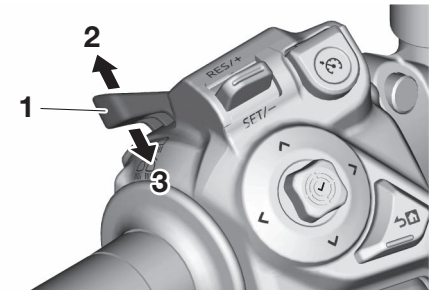

1. Dimmer/Pass switch "☰/☲"
2. Direction A
3. Direction B

Push this switch outward (direction A) to turn the high beam on. Push this switch inward (direction B) to return to low beam.

While the headlights are set to low beam, push the switch inwards (direction B) to momentarily flash the high beam.

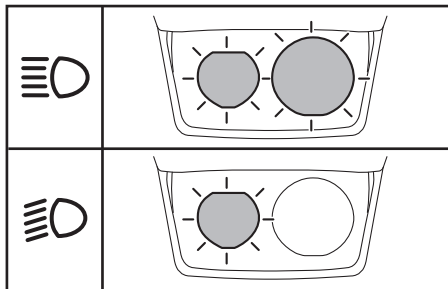

EAU1741

Turn signal switch “/”

This switch controls the turn signal lights. This is a 2-stage switch, meaning that pressing it soft or hard has a different effect.

Soft press: Lightly press the switch in the direction you wish to signal, until a soft click is felt. The corresponding turn signal light will flash three times and stop.

Hard press: Firmly press the switch in the direction you wish to signal, until a stronger click is felt. The corresponding turn signal light will flash continuously until all of the following conditions occur:

- The vehicle travels approx. 150 m (490 ft).
- More than 15 seconds has elapsed.
- The vehicle speed is more than 5 km/h (3 mi/h).

ECA28520

NOTICE

Depending on the conditions, the turn signal may not automatically turned off within the specified time or distance travelled.

To cancel a turn signal manually, press the switch a second time in the same direction.

EAU66030

Horn switch “”

Press this switch to sound the horn.

Stop/Run/Start switch “”

EAU94790

To crank the engine with the starter, set this switch to “”, and then push the switch down towards “”. See page 8-2 for starting instructions prior to starting the engine.

Set this switch to “” to stop the engine in case of an emergency, such as when the vehicle overturns.

EAU91671

Hazard switch “”

Use this switch to turn on the hazard lights (simultaneous flashing of all turn signal lights). The hazard lights are used in case of an emergency or to warn other drivers when your vehicle is stopped where it might be a traffic hazard.

The hazard lights can be turned on or off only when the main switch is in the “ON” position. You can turn the main switch to the “OFF” or “LOCK” position, and the hazard lights will continue to flash. To turn off the hazard lights, turn the main switch to the “ON” position and operate the hazard switch again.

Instrument and control functions

NOTICE

ECA10062

Do not use the hazard lights for an extended length of time with the engine not running, otherwise the battery may discharge.

Cruise control switches

EAAU1930

See page 4-5 for an explanation of the cruise control system.

6

YRC mode button “MODE”

EAAU1941

Short press this button to cycle the YRC mode presets.

Theme1-3: Long press this button to open a YRC mode pop-up at the bottom of the display.

See page 6-11 and 6-27 for more information.

Joystick “✓” and home button “↵”

EAAU1922

These are used to control the display/menu system.

See pages 5-1, 6-10 and 6-17 for more detailed explanations of their function.

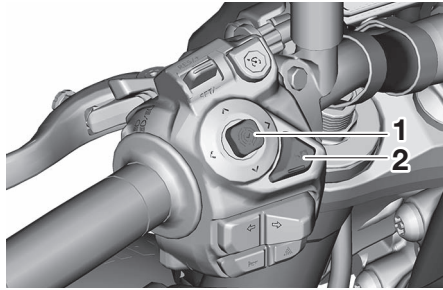

1. Joystick “✓”
2. Home button “↵”

Indicator lights and warning lights

EAAU4939Z

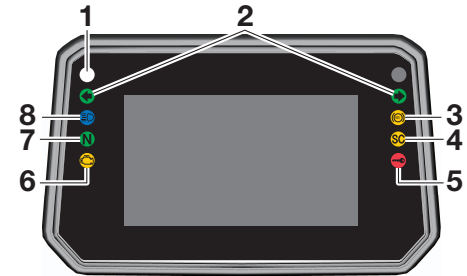

1. Shift indicator light “○”
2. Turn signal indicator lights “←” and “→”
3. ABS warning light “⚠️”
4. Stability control indicator light “SC”
5. Immobilizer system indicator light “⚠️”
6. Engine trouble warning light “🚗”
7. Neutral indicator light “N”
8. High beam indicator light “☑️”

Turn signal indicator lights “←” and “→”

EAAU1910

Each indicator light will flash when its corresponding turn signal lights are flashing.

Neutral indicator light “N”

EAU88300

This indicator light comes on when the transmission is in the neutral position.

High beam indicator light “H”

EAU88310

This indicator light comes on when the high beam of the headlight is switched on.

Engine trouble warning light “E”

EAU88550

This warning light comes on if a problem is detected in the engine. If this occurs, have a Yamaha dealer check the on-board diagnostic system.

TIP

When the vehicle is turned on, this light should come on for a few seconds and then go off. Otherwise, have a Yamaha dealer check the vehicle.

ABS warning light “A”

EAU91500

In normal operation, the ABS warning light comes on when the vehicle is turned on, and goes off after traveling at a speed of 5 km/h (3 mi/h) or higher.

TIP

If the warning light does not work as described above, or if the warning light comes on while riding, the ABS may not work correctly. Have a Yamaha dealer check the vehicle as soon as possible.

WARNING

EWA21120

If the ABS warning light does not turn off after reaching 5 km/h (3 mi/h), or if the warning light comes on while riding:

- Use extra caution to avoid possible wheel lock during emergency braking.
- Have a Yamaha dealer check the vehicle as soon as possible.

Shift indicator light “S”

EAU99711

This indicator light comes on when it is time to shift to the next higher gear. The engine speeds at which it comes on or goes off and other settings can be adjusted in the menu system. (See page 6-32.)

TIP

- The shift indicator light does not operate when the vehicle is in neutral or 6th gear.
- When the vehicle is turned on, this light should come on for a few seconds and then go off. If the light does not come on, or if the light remains on, have a Yamaha dealer check the vehicle.

Immobilizer system indicator light “I”

EAU88350

When the main switch is turned off and 30 seconds have passed, the indicator light will flash steadily to indicate the immobilizer system is enabled. After 24 hours have passed, the indicator light will stop flashing, however the immobilizer system is still enabled.

TIP

When the vehicle is turned on, this light should come on for a few seconds and then go off. If the light does not come on, or if the light remains on, have a Yamaha dealer check the vehicle.

Instrument and control functions

Transponder interference

If the immobilizer system indicator light flashes in the pattern, slowly 5 times then quickly 2 times, this could be caused by transponder interference. If this occurs, try the following.

1. Make sure there are no other immobilizer keys close to the main switch.
2. Use the code re-registering key to start the engine.
3. If the engine starts, turn it off, and try starting the engine with the standard keys.
4. If one or both of the standard keys do not start the engine, take the vehicle and all 3 keys to a Yamaha dealer to have the standard keys re-registered.

TIP

When the vehicle is turned on, this light should come on for a few seconds and then go off. If the light does not come on, or if the light remains on, have a Yamaha dealer check the vehicle.

ECA28540

NOTICE

When turning the main switch on, avoid any movement or vibration of the vehicle as it may interfere with the initialization of the IMU. If this occurs, the traction control system will not operate and the stability control indicator light “SC” will come on until the IMU can initialize.

6

Stability control indicator light “SC”^{EAU1782}

When TCS (traction control system) is set to off, this indicator will come on. This indicator light flashes when the TCS (traction control system), SCS (slide control system), LIF (lift control system), or BSR (back slip regulator) engage while riding.

Display

Theme1



Theme2

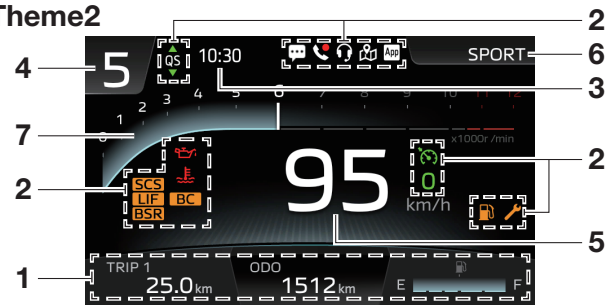

Theme3



Theme4



1. Vehicle information display
2. Indicator icons
3. Clock
4. Transmission gear display

5. Speedometer
6. YRC mode display
7. Tachometer

Instrument and control functions

Minimized display view (while menu system/navigation are open)

When the menu system or the navigation function are open, the information on the main display is relocated as shown.

Theme1, 2, 3



Theme4

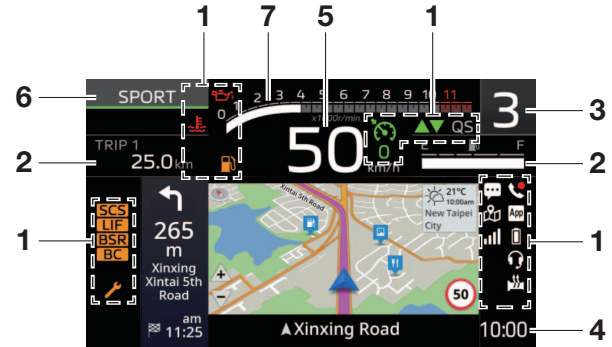

1. Indicator icons
2. Vehicle information display
3. Transmission gear display
4. Clock
5. Speedometer
6. YRC mode display
7. Tachometer

EAUA171A

TIP

- The brightness level of the display screen can be adjusted in the menu system. (See page 6-31.)
- If the display becomes too hot, the display screen brightness levels will automatically reduce to avoid damage.
- This model uses a thin-film-transistor liquid-crystal display (TFT LCD) for good contrast and readability in various lighting conditions. However, due to the nature of this technology, it is normal for a small number of pixels to be inactive.
- The display units can be switched between kilometers-miles and Celsius-Fahrenheit. (See page 6-32.)
- The navigation system display units can be changed separately using the Garmin StreetCross app.

Display system controls

The display user interface is controlled with the joystick / “✓” and the home button “☰”. (See page 6-5.) Each control has various functions for different situations, see the following list for details.

Operate the joystick left-right-up-down:

Main display active: highlights and adjusts items in the vehicle information display, and also the YRC mode display (Theme4).

Navigation active: up-down zoom the map view in-out.

Turn-by-turn pop-up active: left-right adjust the displayed information.

Menu system active: highlight and adjusts various menu items.

Short press “✓”:

Main display active: highlight and select items in the vehicle information display, and also the YRC mode display (Theme4).

Navigation active: directly open the “Navigation” menu display.

Menu system active: select highlighted menu items.

Long press “✓”:

Highlighted vehicle information display item flashing: reset the item.

Smartphone connected with music app: play/pause music.

Short press the home button “☰”:

Main display/navigation active: open the first pop-up layer of the menu system.

Menu system active: cancel/return to previous.

Long press the home button “☰”:

Main display active: switch to navigation display.

Navigation active: switch to main display.

Menu system active: exit to the previously open main display/navigation display.

Instrument and control functions

Clock

The clock uses a 12-hour time system. The clock is updated automatically from connected smartphones or can also be manually set in “Settings” → “Clock”. (See page 6-30.)

Speedometer

The speedometer shows the vehicle’s traveling speed.

6

Tachometer

The tachometer shows the engine speed, as measured by the rotational velocity of the crankshaft, in revolutions per minute (r/min).

ECA10032

NOTICE

Do not operate the engine in the tachometer red zone.

Red zone: 10500 r/min and above

Transmission gear display

This display shows which gear the transmission is in. This vehicle has 6 gears and a neutral position. The neutral position is indicated by the neutral indicator light “N” and by the transmission gear display reading: “N”.

YRC mode display

This display indicates which YRC mode is currently selected: “SPORT”, “STREET”, “RAIN”, “CUSTOM 1” and “CUSTOM 2”.

Cycle through the YRC modes by using the YRC mode button “MODE” and also view/customize them in the menu system. (See page 6-27.)

TIP

The names of “CUSTOM 1” and “CUSTOM 2” can also be customized via the Yamaha Motorcycle Connect app.

In Theme4:

In this theme, the YRC mode display is expanded to show the current “PWR”, “TCS”, “SCS”, and “LIF” settings for each YRC mode. In addition to using the YRC mode button “MODE”, you can move the joystick up-down to cycle between the vehicle information display and the YRC mode display. When highlighted, short press “✓” to select the YRC mode display. Move the joystick left-right to cycle between the available items. Move the joystick

up-down to cycle the highlighted YRC mode or change the setting for the highlighted item.

In Theme1-3:



Long press the YRC mode button “MODE” to open/close an expanded YRC mode pop-up at the bottom of the screen. While the pop-up is open, short press the YRC mode button “MODE” to cycle through the presets and use the joystick to adjust individual items.

TIP

If the selected YRC mode is customizable, “PWR”, “TCS”, “SCS”, and “LIF” can be highlighted and adjusted using the joystick.

For more information on YRC modes see page 4-1.

Vehicle information display

The vehicle information display contains 3 cells which can be set to display the following:

- Odometer (ODO)
- Two tripmeters (TRIP 1 / TRIP 2)
- Fuel reserve tripmeter (TRIP F)
- Instantaneous fuel consumption (INST FUEL)
- Average fuel consumption (AVG FUEL)
- Estimated fuel range (RANGE)
- Coolant temperature (COOLANT)
- Air temperature (AIR)
- Trip timer (TRIP TIME)
- Fuel Meter

In Theme1-3:

- Move the joystick left-right to cycle between the cells. Move the joystick up-down to cycle the display item for the highlighted cell. If a display item is flashing, long press “✓” to reset it.
- It can also be set in “Ⓜ Vehicle Info” in the menu system.

In Theme4:

Move the joystick up-down to cycle between the vehicle information display and the YRC mode display. When highlighted, short press “✓” to select the vehicle information display. Move the joystick left-right to cycle between the cells. Move the joystick up-down to cycle the display item for the highlighted cell. If a display item is flashing, long press “✓” to reset it.

TIP

- Resettable items can also be individually viewed and reset by navigating to “⚙ Settings” → “Information / Reset” in the menu system. (See page 6-25.)
- While on the navigation display, navigate to “Ⓜ Vehicle Info” in the menu system to highlight the two cells.

Odometer (ODO)

The odometer shows the total distance traveled by the vehicle.

TIP

The odometer will lock at 999999 and cannot be reset.

Tripmeters (TRIP 1 / TRIP 2)

“TRIP 1” and “TRIP 2” show the distance traveled since they were last set to zero.

“TRIP 1” and “TRIP 2” will reset to 0 and begin counting again after 9999.9 has been reached.

Fuel reserve tripmeter (TRIP F)

When the fuel tank reserve level has been reached, “TRIP F” activates and begins recording distance traveled from that point. After refueling and traveling some distance, “TRIP F” will automatically deactivate and reset.

TIP

When “TRIP F” is inactive it will show as “--.-”.

Instrument and control functions

Instantaneous fuel consumption (INST FUEL)

When using kilometers, the instantaneous fuel consumption display can be set to “km/L” or “L/100km”. (See page 6-32.)

When using miles, the instantaneous fuel consumption is displayed in “MPG”.

Average fuel consumption (AVG FUEL)

When using kilometers, the average fuel consumption display can be set to “km/L” or “L/100km”. (See page 6-32.)

When using miles, the average fuel consumption is displayed in “MPG”.

Estimated fuel range (RANGE)

The estimated distance that can be traveled under the current riding conditions with the remaining fuel.

Coolant temperature (COOLANT)

The coolant temperature is displayed from $-30\text{ }^{\circ}\text{C}$ ($-22\text{ }^{\circ}\text{F}$) to $130\text{ }^{\circ}\text{C}$ ($266\text{ }^{\circ}\text{F}$) in $1\text{ }^{\circ}\text{C}$ ($1\text{ }^{\circ}\text{F}$) increments.

TIP

- When using Celsius, the coolant temperature display will read “-30” when the vehicle coolant temperature is below $-30\text{ }^{\circ}\text{C}$.
- When using Fahrenheit, the coolant temperature display will read “-22” when the vehicle coolant temperature is below $-22\text{ }^{\circ}\text{F}$.
- If the vehicle coolant temperature is too high the coolant temperature display will read “Hi”.

Air temperature (AIR)

The air temperature is displayed from $-9\text{ }^{\circ}\text{C}$ ($15\text{ }^{\circ}\text{F}$) to $50\text{ }^{\circ}\text{C}$ ($122\text{ }^{\circ}\text{F}$) in $1\text{ }^{\circ}\text{C}$ ($1\text{ }^{\circ}\text{F}$) increments. The temperature displayed may vary from the actual ambient temperature.

TIP

- “---” will be displayed if the detected temperature is lower than $-9\text{ }^{\circ}\text{C}$ ($15\text{ }^{\circ}\text{F}$).
- “---” will be displayed if the detected temperature is higher than $50\text{ }^{\circ}\text{C}$ ($122\text{ }^{\circ}\text{F}$).

Trip timer (TRIP TIME)

Displays the engine running time.

Fuel Meter

The fuel meter indicates the amount of fuel in the fuel tank. The display segments of the fuel meter disappear from “F” (full) towards “E” (empty) as the fuel level decreases. When the last segment starts flashing, refuel as soon as possible.

ECAE0121

NOTICE

Do not let the vehicle run completely out of fuel. This may cause damage to the catalytic converter.

Warning and indicator icons

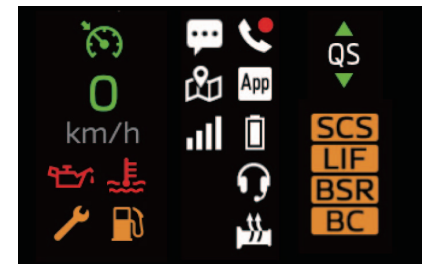

Instrument and control functions

Low fuel indicator “”

This icon comes on when approximately 2.5 L (0.66 US gal, 0.55 Imp.gal) of fuel remains in the tank.

Coolant temperature warning “”

This icon appears when the coolant temperature is high. Stop the vehicle and turn off the engine. Allow the engine to cool.

NOTICE

Do not continue to operate the engine if it is overheating.

Oil pressure warning “”

This icon appears when the engine oil pressure is low. When the vehicle is first turned on, engine oil pressure has yet to build, so this indicator will come on and stay on until the engine has been started.

TIP

If a malfunction is detected, this icon will flash repeatedly.

NOTICE

Do not continue to operate the engine if the oil pressure is low.

Auxiliary system warning “”

This icon appears if a problem is detected in a system not related to the engine.

Quick shift indicator “QS”

This icon and accompanying arrow icons indicate the status of the quick shifter.

Respective arrow icon off: the quick shifter is disabled.

“▲”: the system is active for upshifts but cannot currently quickshift.

“▼”: the system is active for downshifts but cannot currently quickshift.

“▲”: quick upshift available.

“▼”: quick downshift available.

TIP

- The upshift and downshift functions are independent and can be activated separately in the menu system. (See page 6-27.)

ECA26410

- For more information on the quick shifter see page 4-3.

Network connectivity indicator “”

This icon indicates the connected smartphone's network connection status.

Icon off: No smartphone connected.

: A smartphone is connected but has no network connectivity.

: A smartphone is connected and has network connectivity. The icon segments indicate the signal strength.

TIP

This icon may not operate with some smartphone models, even if the connected smartphone has network connectivity.

Smartphone battery level indicator “”

This icon indicates the connected smartphone's battery level.

Icon off: No smartphone connected.

: The center bar moves up and down to indicate the battery level.

: Smartphone is charging.

Instrument and control functions

TIP

The battery level indicated by the icon may not always be consistent with the battery level displayed on the smartphone.

Headset indicator “”

This icon comes on if a Bluetooth headset is connected to the smartphone.

TIP

For some smartphones, this icon may go off during phone calls.

Yamaha Motorcycle Connect app indicator “”

This icon comes on when the Yamaha Motorcycle Connect app is successfully connected to the vehicle.

: The icon turns yellow when the connected smartphone becomes overheated.

TIP

Depending on the smartphone, the icon may remain yellow even after the smartphone is no longer overheating.

Navigation connection indicator “”

This icon comes on when the Garmin StreetCross app is connected.

Telephone indicator “”/“”

This icon comes on green when there is an active call and red when there is a recent missed call. The missed call icon will disappear when the recent contact list is opened at “ Applications” → “Phone” in the menu system.

Notification indicator “”

This icon comes on when the connected smartphone receives an SNS, Email or other notification. After that, the icon stays on until you turn the vehicle off. Check the notifications by navigating to “ Applications” → “Notification” in the menu system.

TIP





- This function works only when a smartphone is connected to the CCU via the Yamaha Motorcycle Connect app.

- Permission to access notifications must be granted to the Yamaha Motorcycle Connect app on your smartphone.

Grip warmer indicator “” (if equipped)

The grip warmers can be used when the engine is running. There are 3 customizable temperature presets that can be customized between 10 different temperature levels. (See page 6-24.)

The icon displays the current temperature setting:

- : Grip warmer off
- : Low preset
- : Medium preset
- : High preset

ECA17932

NOTICE

- Be sure to wear gloves when using the grip warmers.
- Do not use the grip warmers in warm weather.

Instrument and control functions

- If the handlebar grip or throttle grip becomes worn or damaged, stop using the grip warmers and replace the grips.

BC indicator “BC”

This icon comes on if “BC” (brake control system) is deactivated.

ECA28551

NOTICE

When turning the main switch on, avoid any movement or vibration of the vehicle as it may interfere with the initialization of the IMU. If this occurs, the brake control system will not operate and the BC indicator “BC” will come on until the IMU can initialize.

SCS indicator “SCS”

This icon comes on if “SCS” (slide control system) is deactivated.

LIF indicator “LIF”

This icon comes on if the “LIF” (lift control system) is deactivated.

BSR indicator “BSR”

This icon comes on if the “BSR” (back slip regulator) is deactivated.

Cruise control indicator “ / / ”

This icon comes on if the cruise control system is on standby, turns green when the system is active, or amber if there is an error.

For more information on the cruise control system see page 4-5.

Set speed indicator “ $\frac{0}{0}$ ” km/h / km/h

This indicator displays the current set speed of the cruise control system. This icon comes on if the cruise control system is on standby and turns green when the system is active.

For more information on the cruise control system see page 4-5.

Navigation Display

There are 3 display modes for route guidance: “Default View”, “Turn-by-Turn”, and “Turn List”.

Default View



In “Default View” mode: Operate the joystick up-down to zoom in/out.

Turn List

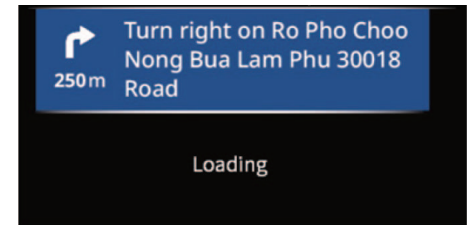

In “Turn List” mode: Operate the joystick up-down to scroll through the list of turns on the route.

Instrument and control functions

Turn-by-Turn



6

In “Turn-by-Turn” mode: Operate the joystick left-right to cycle the information at the bottom of the display between distance remaining to destination/estimated time to arrival and current location.

Short press “✓” to open the menu system and navigate to “App Applications” → “Navigation” → “Change View” to switch between the display modes. (See page 6-18.)

TIP

- If the Bluetooth connection becomes unstable, the navigation display may automatically change to the “Turn-by-Turn” mode or freeze with a loading animation.

When the connection improves, the navigation display will return to the former setting.

- For some smartphones, using the phone function while navigation is in progress may display a connection error after returning to the navigation display. If this happens, follow the instructions on the display. (See page 5-8.)
- If the connected smartphone’s AI assistant function is deactivated in the smartphone’s settings, and a headset is also connected, a connection error may be displayed when using the navigation home display (iOS only).

Menu system

EAU2571



1. Pop-up menu

The menu system for this vehicle is controlled with the joystick/home button on the left handlebar. (See page 6-5.)

The first layer of the menu is a pop-up at the bottom of the main display. Deeper layers of the menu system are viewed using the minimized display view.

To open the pop-up menu from the main display:

Short press the home button “”.

Menu system operation:

- Operate the joystick left-right-up-down to highlight and adjust menu items.
- Short press “✓” to select an item.







Instrument and control functions





- Short press the home button “

TIP

When arrows appear “

The pop-up menu is divided into the following main functions:

 “Theme”	Select the visual theme of the display. (See page 6-18.)
 “Applications”	Access the smartphone related functions. (See page 6-18.)
 “Grip Warmer” (if equipped)	Control the grip warmers. (See page 6-24.)
 “Vehicle Info”	Reset/cycle the vehicle information display items. (See page 6-24.)
 “Settings”	Adjust settings related to the vehicle’s operation. (See page 6-25.)
 “Phone” (if call active)	Open the telephone function for an active call. (See page 6-33.)

 “Music”	Access simple pop-up audio player. (See page 6-34.)
 “Navigation”	Open the navigation display. (See page 6-34.)
 “Meter Display”	Open the main display. (See page 6-34.)
 “Turn-by-Turn”	Activate Turn-by-Turn route guidance. (See page 6-34.)
 “Turn-by-Turn OFF”	De-activate Turn-by-Turn route guidance. (See page 6-34.)

TIP

- If the vehicle is in motion, “

“ The visual theme of the main display can be changed between four options. (See page 6-8.)

“ Applications” → “Navigation”



This menu contains the following commands for the navigation system:

- “Change View”
- “Stop Navigation”
- “Skip Next Stop”
- “Go Home”
- “Go to Work”
- “Favorites”
- “Nearby Gas Stations”

TIP

- Except for the commands listed above, operate the navigation system using the Garmin StreetCross app on your smartphone.

Instrument and control functions

- “Change View”, “Stop Navigation” and “Skip Next Stop” are not available unless route guidance is active.

See page 6-16 for more information on the navigation system.



When a command is used to select a destination, the navigation display will open and show the new/updated route.

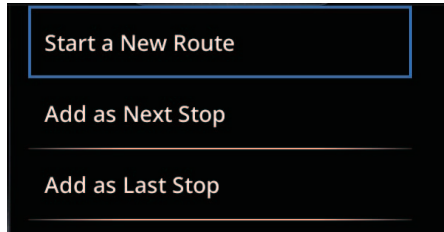

If route guidance is already active when a command is used to select a destination, the following options will be available:

“Start a New Route”: Cancels previous route and sets route to new destination.

“Add as Next Stop”: Adds new destination as the next stop in the current route.

“Add as Last Stop”: Adds new destination as the last stop in the current route.

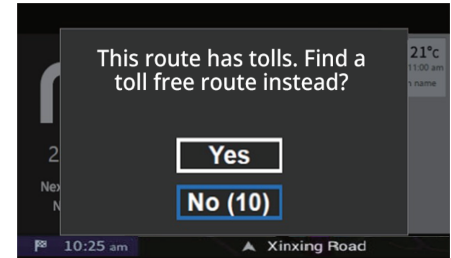

If a route requires a toll, you will be prompted to search for another route without tolls. Select “Yes” to find a route without tolls. Select “No” to accept the current route.

TIP

After 10 seconds, the route (with tolls) will be selected automatically.

“Change View”

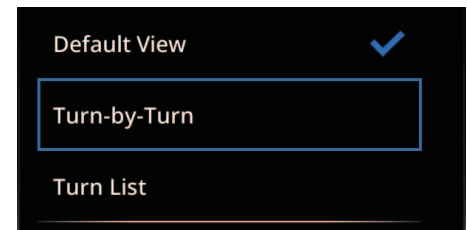

Instrument and control functions

This menu changes the navigation system display mode (Default View/Turn List/Turn-by-Turn). After selection, the navigation display will open in the selected display mode.

“Stop Navigation”

Cancels the current route guidance and opens the navigation home display.

“Skip Next Stop”

Skips the next stop in your planned route and opens the navigation home display.

“Go Home”

Sets route guidance for home location (home location must already be set in the Garmin StreetCross app).

“Go to Work”

Sets route guidance for work location (work location must already be set in the Garmin StreetCross app).

“Favorites”

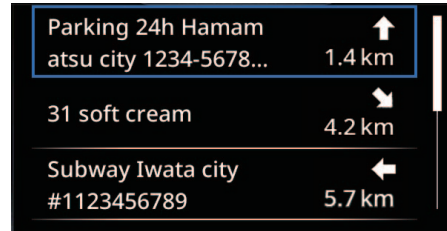

Shows a list of saved locations and their distance from current location (must have saved locations in the Garmin StreetCross).

TIP

If route guidance is in progress, arrows appear showing the direction to the saved locations. The current direction of travel is indicated by the upwards arrow.

“Nearby Gas Stations”



Shows a list of nearby gas stations and their distance from current location.

TIP

If route guidance is in progress, arrows appear showing direction to the gas stations. The current direction of travel is indicated by the upwards arrow.

Instrument and control functions

“ Applications” → “Music”

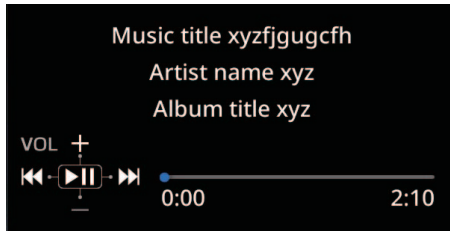

6

This opens an audio player which interfaces with your smartphone’s audio player app.

Operate the joystick up-down to adjust the volume.

Operate the joystick left-right to skip to the next/previous track.

Short press “” to play/pause the track.

TIP

- All audio track information is imported from the music player application on your smartphone.
- Depending on the smartphone and music player application, the audio player may start playing automatically, the track information

may not display, or the next/previous track and volume adjustment may not function.

“ Applications” → “Phone”



This is a list of recent telephone calls (since connection to CCU) from the connected smartphone. When this list has been viewed, the missed call indicator “” will disappear.

: Inbound missed call (red arrow)

: Inbound call (green arrow)

TIP

- Repeated calls for the same contact are indicated by the number next to the contact in brackets.

- The maximum number of stored items is 30; when the limit is reached, older items will be deleted.

“ Applications” → “Weather”

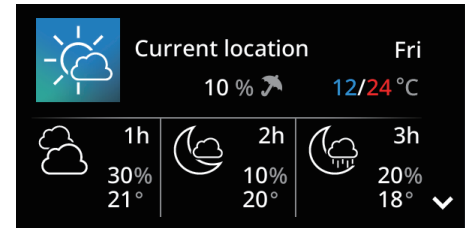

This menu displays weather information at your current location. Operate the joystick up-down to change the timeframe of the weather information (hourly/daily).

TIP

The weather information in this menu may be different than on the navigation home display.

Instrument and control functions

“ Applications” → “Notification”

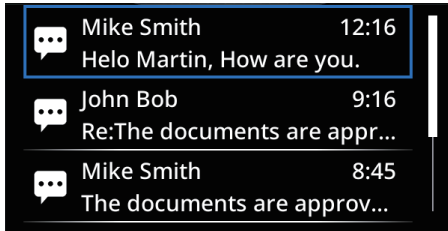

This is a list of notifications (since connection to CCU) from the connected smartphone. Select an item to read the notification message. The notification indicator “” will not turn off until the vehicle power is turned off.

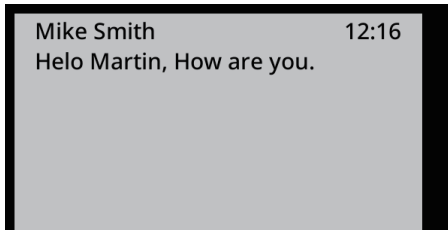

TIP

- For some smartphones and/or applications, notifications may not function.
- The maximum number of stored items is 30. When the limit is reached, older items will be deleted.
- If a message is too long then not all of it will be displayed.
- Messages cannot be opened and read while the vehicle is in motion.
- Notification timestamps may be slightly different than when displayed on your smartphone.

“ Applications” → “Information Transfer”

This menu allows you to transfer and display images on the display using the Yamaha Motorcycle Connect app.

“ Applications” → “Connectivity Settings” → “Connection” → “Bluetooth”

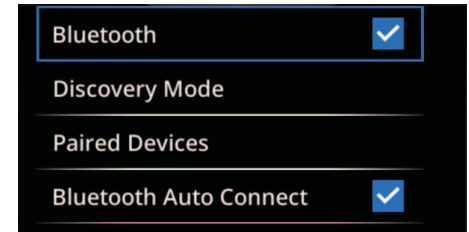

“Bluetooth”

Turns the CCU’s Bluetooth ON/OFF. The checkmark indicates ON.

“Discovery Mode”

Puts the CCU in Bluetooth discovery mode when pairing a smartphone. See page 5-3 for more information about Bluetooth pairing.

Instrument and control functions

“Paired Devices”

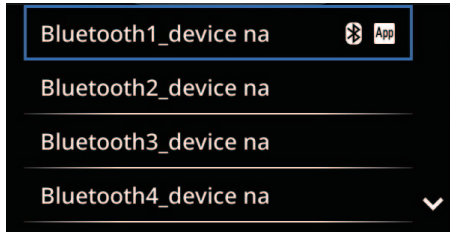

6

Paired smartphones are listed here. The Yamaha Motorcycle Connect app symbol “

TIP _____
There is a maximum of 8 paired devices.

Select a device name for more options:

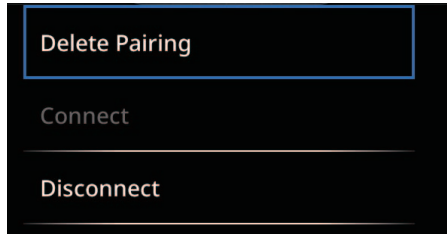

“Delete Pairing”: Deletes the selected paired device from the CCU memory.
“Connect”: Connect to the selected paired device.
“Disconnect”: Disconnect from the selected paired device.

TIP _____
If “Bluetooth Auto Connect” is on, the CCU may immediately reconnect to the smartphone after being disconnected.

“Bluetooth Auto Connect”
Turns the Bluetooth automatic connection ON/OFF. The checkmark indicates ON. When the auto connect is ON, the CCU will automatically connect to the last connected device. If it

is not available, the CCU will attempt to connect to another device in the paired device list.

TIP _____
If “Bluetooth Auto Connect” is OFF, previously paired devices can be connected manually via the “Paired Devices” list.

“ **Applications**” → “**Connectivity Settings**” → “**System Information**”

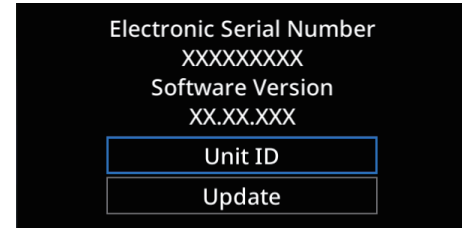

This menu displays the current system software version.

Instrument and control functions

“Unit ID”



This menu contains a QR code with the CCU's unit identification number. Short press “✓” to return to the previous menu.

TIP

The CCU's unit ID is only required for dealer service operations.

“ Applications” → “Connectivity Settings” → “Legal Information”



Third-party license agreements can be viewed here.

“ Grip Warmer” (if equipped)

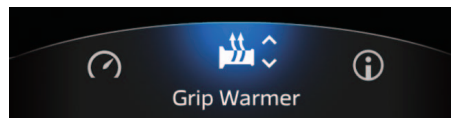

With this item highlighted, operate the joystick up-down to cycle between grip warmer OFF and 3 presets which can be customized in “ Settings” → “Grip Warmer Settings”. (See page 6-32.)

With this item highlighted, long press “✓” to shortcut to “ Settings” → “Grip Warmer Settings” where the grip warmer presets can be further customized.

TIP

Theme4: This function is not accessible via the menu system and is instead located within the vehicle information display. The function is the same.

“ Vehicle Info”

This allows you to adjust the vehicle information display items. (See page 6-12.)

TIP

This function is not available in Theme4.

Instrument and control functions

“Settings”

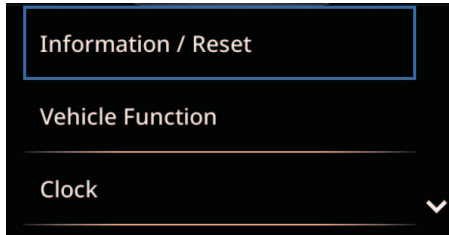

“Settings” → “Information / Reset”

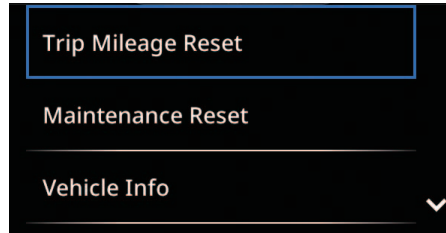

This menu allows reset of the tripmeters on the vehicle information display. Operate the joystick to highlight an item. Short press “✓” to reset the item. Confirm by selecting “OK”.

TIP

“TRIP F” can only be selected when the fuel is low. Otherwise the item is grayed out.

6

The “Settings” menu contains the following:

“Information / Reset”	Reset vehicle information. (See page 6-25.)
“Vehicle Function”	Adjust vehicle electronic rider aids. (See page 6-27.)
“Clock”	Adjust time/set automatic update. (See page 6-30.)
“Display”	Change display brightness and background settings. (See page 6-31.)
“Unit”	Change the display units. (See page 6-32.)
“Grip Warmer Settings” (if equipped)	Customize the grip warmer presets. (See page 6-32.)
“Shift Indicator”	Change the shift indicator settings. (See page 6-32.)
“Connectivity Settings”	Smartphone connectivity settings. (See page 6-22.)

This menu allows the viewing and reset of tripmeters, maintenance tripmeters, vehicle information items, and the mass reset of other settings to factory defaults.

“Trip Mileage Reset”



“Maintenance Reset”



This menu allows you to record distance traveled between engine oil changes “OIL” and two other maintenance items of your choice “FREE-1” and “FREE-2”. After maintenance to one of the items has been completed,

Instrument and control functions

operate the joystick to highlight the item. Short press “✓” to reset the item. Confirm by selecting “OK”.

“Vehicle Info”

AVG SPEED	56 km/h
AVG FUEL	39.3 L/100km
TRIP TIME	45:31

This menu allows reset of the vehicle information display items. Operate the joystick to highlight an item. Short press “✓” to reset the item. Confirm by selecting “OK”

“All Reset”

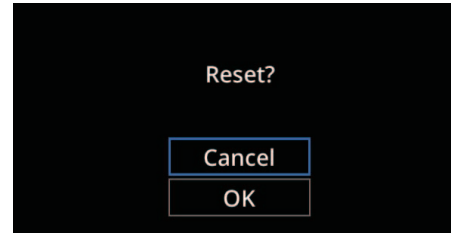

Use this menu to mass reset the multi-function meter to its default settings. This includes YRC settings, display settings, grip warmer presets, traction control, units, Bluetooth connection settings, and vehicle information display items. Confirm by selecting “OK”.

TIP

- After a reset, the display will restart and may take several minutes to reboot.
- If “All Reset” is executed, the corresponding pairing record must be deleted from the smartphone in order to pair again.

- Before selling or changing ownership of the vehicle, reset the multi-function meter to ensure all personal data from your smartphone (i.e., call history and contact information) is deleted.
- After the multi-function meter is reset, Bluetooth pairing records and the Yamaha Motorcycle Connect app pairing records must be deleted from your smartphone. If this is not completed, the CCU will not be able to pair with the smartphone again.
- The multi-function meter cannot be reset while the vehicle is in motion.

Instrument and control functions

“ Settings” → “Vehicle Function”
→ “YRC Settings” → “YRC Modes”

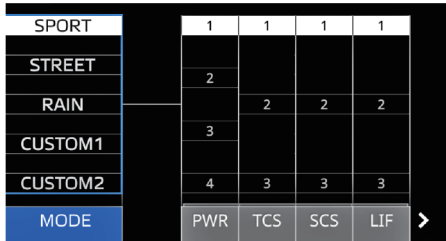

6

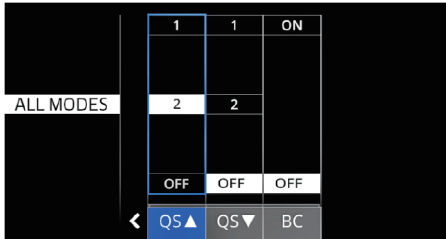



This menu allows you to:

- View the five YRC mode presets: “SPORT”, “STREET”, “RAIN”, “CUSTOM 1” and “CUSTOM 2”.

- Customize the “PWR”, “TCS”, “SCS” and “LIF” setting levels for the “CUSTOM 1” and “CUSTOM 2” YRC mode presets.
- Customize the “QS ▲”, “QS ▼” and “BC” setting levels for all YRC mode presets.

Operate the joystick up-down to select the YRC mode preset that you want to adjust.

Operate the joystick left-right to select the YRC item that you want to adjust. Adjust the selected YRC item by operating the joystick up-down.

Short press “” to switch to a visual representation of the highlighted YRC item. Short press the home button “” to exit the visual representation.

Short press the home button “” to save and go back to the previous menu.

TIP

- The names and setting levels for “CUSTOM 1” and “CUSTOM 2” can also be changed via the Yamaha Motorcycle Connect app. (See page 6-30.)

- Adjustments to “QS” or “BC” settings affect all YRC mode presets.

“PWR” (Power delivery mode)

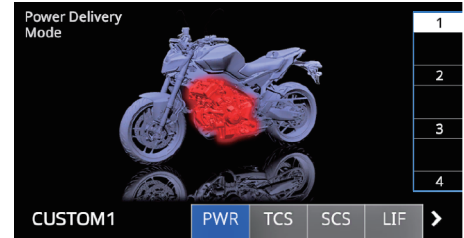

“PWR” can be set to 1, 2, 3 and 4. (See page 4-1.)

Level 1 - Sporty engine response.

Level 2 - Moderate engine response.

Level 3 - Mild engine response.

Level 4 - Rainy days or whenever less engine power is desirable.

Instrument and control functions

“TCS” (Traction control system)

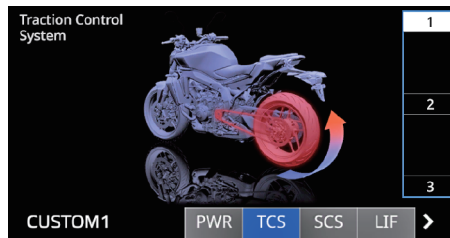

This model uses a variable traction control system. For each setting level, the farther the vehicle is leaned over, the more traction control (system intervention) is applied. There are 3 setting levels available. Level 1 applies the least system intervention, while level 3 applies the most overall traction control to reduce rear wheel slippage. (See page 4-2.)

Level 1 - Suitable for more sporty riding.

Level 2 - Suitable for street riding.

Level 3 - Suitable for riding on wet or slippery surfaces.

TIP

The traction control system can only be turned off completely via “Settings” → “Vehicle Function” → “Stability Control ON/OFF”. (See page 6-30.)

“SCS” (Slide control system)

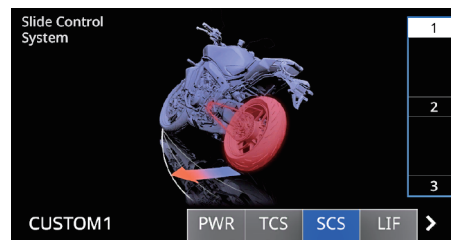

“SCS” can be set to 1, 2, and 3. Setting level 1 provides the least amount of system intervention, and setting level 3 provides the greatest amount of system intervention to reduce lateral wheel slippage. (See page 4-2.)

Level 1 - Suitable for racing more sporty riding.

Level 2 - Suitable for street riding.

Level 3 - Suitable for riding on wet or slippery surfaces.

TIP

The slide control system can only be turned off completely via “Settings” → “Vehicle Function” → “Stability Control ON/OFF”. (See page 6-30.)

“LIF” (Lift control system)

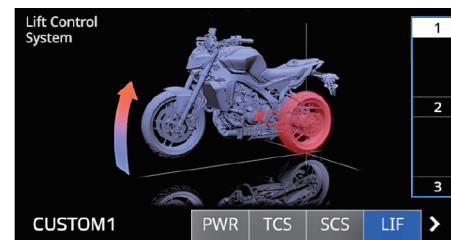

“LIF” can be set to 1, 2, and 3. Setting level 1 provides the least amount of system intervention and setting 3 most strongly reduces the amount of wheel lift. (See page 4-3.)

Level 1 - Least lift control. Suitable for more sporty riding.

Level 2 - More lift control. Suitable for sporty riding.

Level 3 - Most lift control. Suitable for street riding.

Instrument and control functions

TIP

The lift control system can only be turned off completely via “Settings” → “Vehicle Function” → “Stability Control ON/OFF”. (See page 6-30.)

“QS △” / “QS ▽” (Quick shifter)

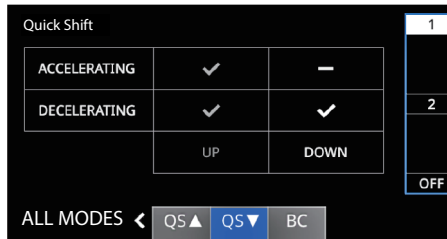
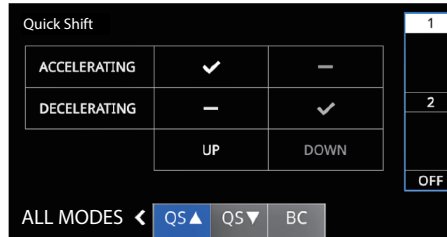

The quick shifter is divided into “QS △” (upshift) and “QS ▽” (downshift) sections. “QS △” and “QS ▽” are not linked and can be set independently. (See page 4-3.)

Setting 1: Can quick upshift only while accelerating. Can quick downshift only while decelerating.

Setting 2: Can quick upshift while accelerating or decelerating. Can quick downshift while decelerating or accelerating.

“OFF” turns the respective upshift or downshift function off, and the clutch lever must then be used when shifting in that direction.

TIP

- Setting 1 has more limited conditions for quickshifts and may be preferable for preventing unintentional gearshifts if the shift pedal is touched accidentally when track riding.
- Setting 2 allows quickshifts under a wider array of conditions to better suit normal riding.

- “QS △” / “QS ▽” ON/OFF status is reflected by the quick shifter indicator. (See page 6-13.)

“BC” (Brake control system)

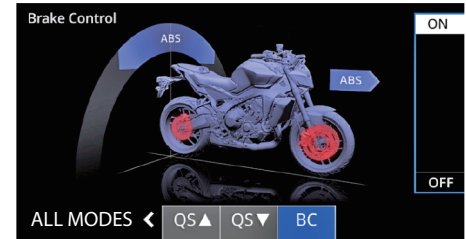

OFF: Only the standard ABS (anti-lock brake system), which adjusts brake pressure based on vehicle speed and wheel speed data. The standard ABS is designed to engage and maximize braking when the vehicle is upright.

ON: ABS (Anti-lock brake system) and cornering assist braking are both active. In addition to the standard ABS, it suppresses the increase in brake pressure when unavoidable abrupt braking occurs during cornering, making the vehicle’s recovery to upright position more gradual.

Instrument and control functions

Also, additional data from the IMU regulates applied brake power depending on lean angle in order to increase the feeling of stability and to suppress wheel lock.

See page 4-3 for more information on the brake system.

TIP

For skilled riders or when track riding, a variety of conditions may cause BC to brake faster than expected for a desired cornering speed or intended cornering line.

“ Settings” → “Vehicle Function” → “YRC Settings” → “Import / Export to App”

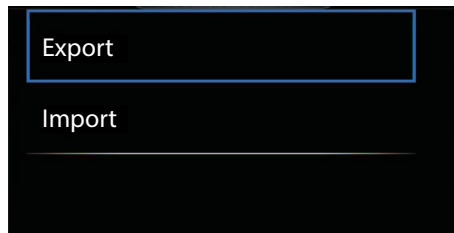

This menu allows you to import/export custom YRC mode settings using the Yamaha Motorcycle Connect app.

“ Settings” → “Vehicle Function” → “Stability Control ON/OFF”



This menu allows you to activate/deactivate the stability control systems: “Traction Control” (TCS), “Slide Control” (SCS), “Lift Control” (LIF), and “Back Slip Regulator” (BSR). (See page 4-1.)

If a system is turned off, the corresponding indicator will come on. (See page 6-13.)

Turning on/off “TCS” will turn “SCS”, “LIF” and “BSR” on/off together. The stability control system indicator light “” will come on to indicate

“TCS” OFF status. (See page 6-7.)

TIP

“TCS” turns on automatically when the vehicle power is turned on.

“ Settings” → “Clock”

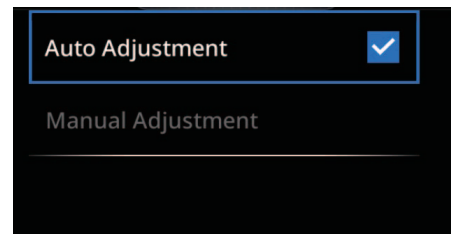

The clock can be set to auto-adjust in sync with a smartphone. “Auto Adjustment” ON is indicated by the checkmark and requires a connection with the Yamaha Motorcycle Connect app. (See page 5-2.) “Manual Adjustment” allows the clock to be calibrated manually.

Instrument and control functions

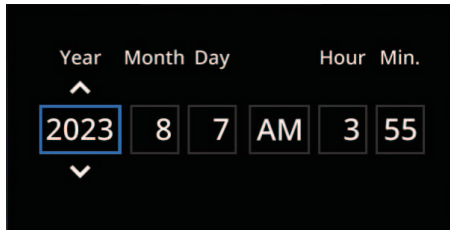

6

To manually adjust the clock, operate the joystick left-right to highlight an item and up-down to adjust the highlighted item. Short press “✓” to finalize the clock setting and then select “OK” to confirm.

“Settings” → “Display” → “Brightness”

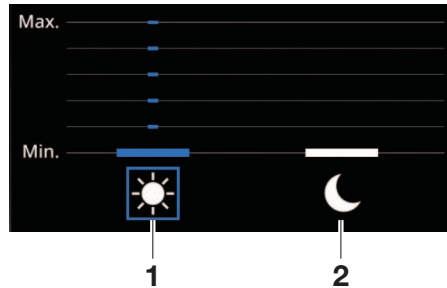

1. Day preset
2. Night preset

The multi-function meter is equipped with a sensor to detect ambient lighting conditions and automatically switch the display between day/night presets. The preset brightness levels can be customized here.

Select a preset by operating the joystick left-right and adjust its brightness level from 1-6 by operating the joystick up-down. Short press “✓” to confirm the setting and return to the previous menu.

TIP

Only adjust brightness presets in ambient light conditions which are appropriate for that preset.

“Settings” → “Display” → “Background”



The multi-function meter is equipped with a sensor to detect ambient lighting conditions and adjust the display between day/night presets. Select “White” (day) or “Black” (night) to keep the display in that preset. Select “Auto” to enable automatic switching depending on the ambient light levels.

Instrument and control functions

“Settings” → “Unit”

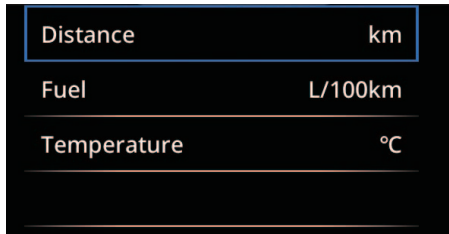

The display units can be customized as follows:

- “Distance”: “km” or “mile”
- “Fuel”: “km/L”, “L/100km” or “MPG”
- “Temperature”: “°C” or “°F”

When “mile” is selected for the distance unit, the fuel consumption unit is automatically changed to “MPG”. At this time, the “Fuel” is grayed out and cannot be selected.

“Settings” → “Grip Warmer Settings” (if equipped)

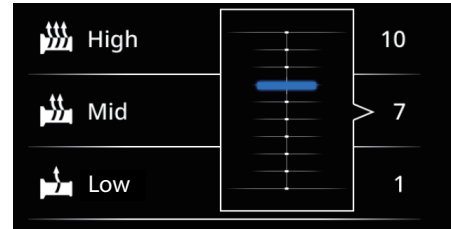

The three grip warmer presets can be customized here. Short press “✓” to select a preset and then adjust its heat level from 1-10 by operating the joystick up-down. Short press “✓” to confirm the setting and return to the previous menu.

“Settings” → “Shift Indicator”

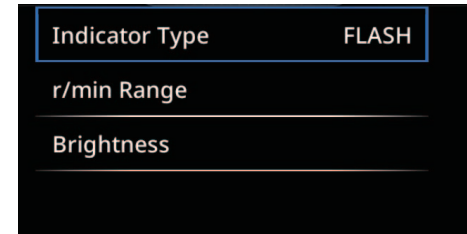

This menu contains settings for the shift indicator light.

“Indicator Type”



Select “ON” to have the indicator come on at the final r/min. Select “FLASH” to have the indicator start flashing at the initial r/min. When the fi-

Instrument and control functions

nal r/min is reached, the indicator light will start flashing at a higher frequency. Select “OFF” to turn the indicator off. Short press “✓” to select the highlighted option and return to the previous menu.

TIP

The shift indicator light will come on or flash as a demonstration of each setting in this menu as it is selected.

6

“r/min Range”

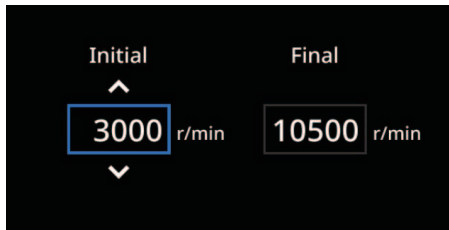

Select the r/min at which the shift indicator light will come on. The operational range is 3000–10500 r/min. It can be adjusted by 250 r/min increments. Short press “✓” to confirm the setting and return to the previous menu.

TIP

- The “Initial” r/min cannot be higher than the “Final” r/min.
- The shift indicator light does not come on when in neutral or 6th gear.

“Brightness”

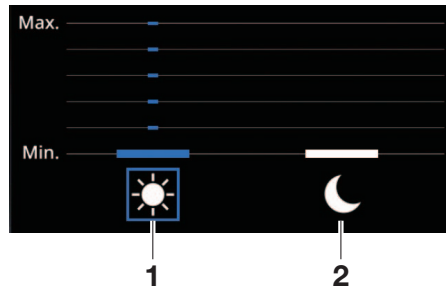

1. Day preset
2. Night preset

Select the day/night brightness levels of the shift indicator light from 1-6 by operating the joystick up-down. Short press “✓” to confirm the setting and return to the previous menu.

TIP

Only adjust brightness presets in ambient light conditions which are appropriate for that preset.

“Phone” (if call active)



Selecting this menu opens an active call display. The contact name and call time are displayed.

Operate the joystick up-down to adjust the call volume.

Short press “✓” to end the call.

TIP

Call volume control and/or ending call via the vehicle is not available for all types of smartphones. If this function is unavailable, the volume adjustment and end call graphics will be grayed out. If this occurs, the call can be controlled directly on your smartphone.

Instrument and control functions

“🎵 Music”

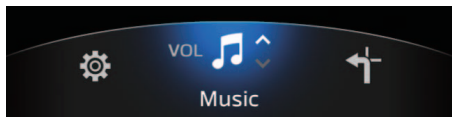

While this item is shown in the menu, operate the joystick up-down to adjust the volume.

Short press “✓” to open additional audio controls.



This opens an audio player which interfaces with your smartphone’s audio player app.

Operate the joystick up-down to adjust the volume.

Operate the joystick left-right to skip to the next/previous track.

Short press “✓” to play/pause the track.

TIP

- All audio track information is imported from the music player application on your smartphone.
- Depending on the smartphone and music player application, the audio player may start playing automatically, or the next/previous track and volume adjustment may not function.
- Theme4: This function is not accessible via the menu system and is instead located within the vehicle information display. The function is the same.

“📍 Navigation”

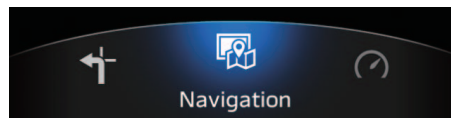

This opens the navigation display. This menu option is only available from the main display.

“📊 Meter Display”



This opens the main display. This menu option is only available from the navigation display.

“📍 Turn-by-Turn / Turn-by-Turn OFF”



This activates/deactivates a turn-by-turn route guidance at the bottom of the main display.

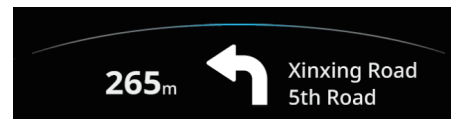

This menu option is only available from the main display.

Instrument and control functions

Clutch lever

EAU1802

To disengage the drivetrain from the engine, such as when shifting gears, pull the clutch lever toward the handlebar. Release the lever to engage the clutch and transmit power to the rear wheel.

TIP

The lever should be pulled rapidly and released slowly for smooth shifting. (See page 8-3.)

Adjusting the clutch lever

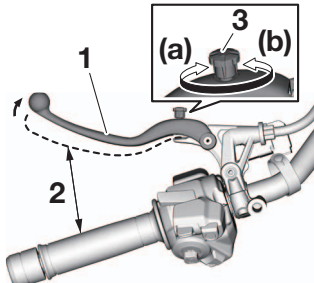

1. Clutch lever
2. Distance
3. Clutch lever position adjusting knob

To adjust the distance between the clutch lever and the handlebar, gently push the lever away from the handlebar and rotate the clutch lever position adjusting knob.

Turn the adjusting knob in direction (a) to increase the distance. Turn the adjusting knob in direction (b) to decrease the distance.

Shift pedal

EAU83692

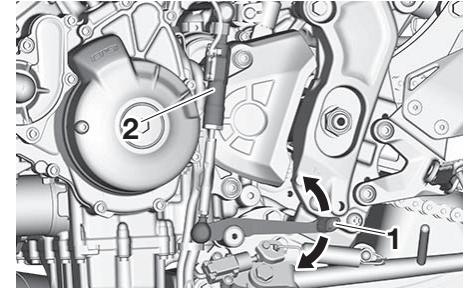

1. Shift pedal
2. Shift rod

The shift pedal is located on the left side of the motorcycle. To shift the transmission to a higher gear, move the shift pedal up. To shift the transmission to a lower gear, move the shift pedal down. (See page 8-3.)

The shift rod is equipped with a shift sensor, which is part of the quick shifter. The shift sensor reads up and down movement, as well as the strength of the input force when the shift pedal is moved.

TIP _____
To prevent unintended shifts, the quick shifter is programmed to ignore unclear input signals. Therefore, be sure to shift using quick and sufficiently forceful inputs.

Brake lever

EAU93083

The brake lever is located on the right side of the handlebar. To apply the front brake, pull the lever toward the throttle grip.

Turn the adjusting knob in direction (a) to increase the distance. Turn the adjusting knob in direction (b) to decrease the distance.

Adjusting the brake lever

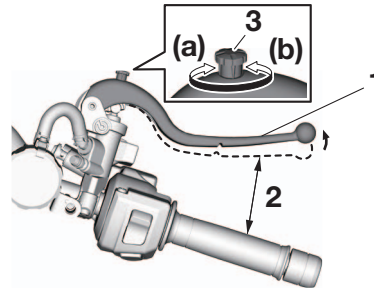

1. Brake lever
2. Distance
3. Brake lever position adjusting knob

To adjust the distance between the brake lever and the handlebar, gently push the lever away from the handlebar and rotate the brake lever position adjusting knob.

Instrument and control functions

Brake pedal

EAU12944

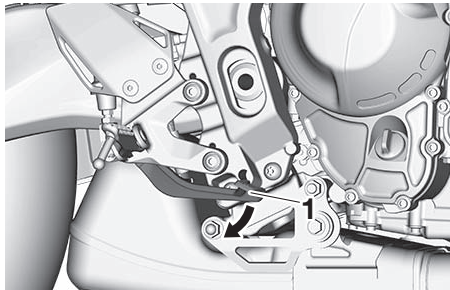

1. Brake pedal

6

The brake pedal is located on the right side of the motorcycle. To apply the rear brake, press down on the brake pedal.

Brake system

EAUA1980

This vehicle is equipped with an integrated anti-lock brake system (ABS).

How to operate the brakes:

Operate the brake lever and brake pedal the same as you would conventional brakes. If wheel slip is detected while braking, ABS will activate and a pulsating sensation may be felt at the brake lever or brake pedal. Continue to apply the brakes and let the ABS work. Do not pump the brakes as this will reduce braking effectiveness.

TIP

The ABS performs a self-diagnostic test when the vehicle starts off and reaches a speed of 5 km/h (3 mi/h). During this test, a clicking noise may be audible from the hydraulic control unit, and some vibration may be felt at the brake lever or pedal, but this is normal.

Anti-lock brake system (ABS)

The anti-lock brake system (ABS) acts on the front and rear brakes independently.

EWA16051

! WARNING

Always keep a sufficient distance from the vehicle ahead to match the riding speed even with ABS.

- **The ABS performs best with long braking distances.**
- **On certain surfaces, such as rough or gravel roads, the braking distance may be longer with the ABS than without.**

ECA20100

NOTICE

Be careful not to damage the wheel sensor or wheel sensor rotor; otherwise, improper performance of the ABS will result.

EAU13077

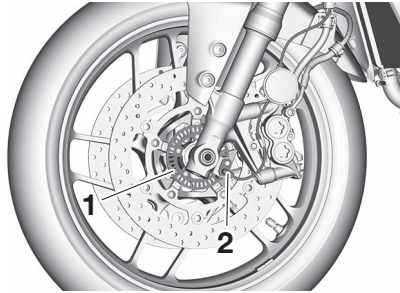

1. Front wheel sensor rotor
2. Front wheel sensor

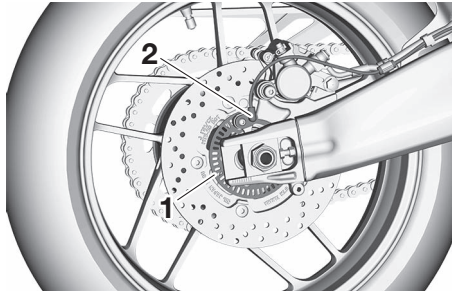

1. Rear wheel sensor rotor
2. Rear wheel sensor

This vehicle is equipped with various electronic control settings for the braking system. For more information see page 4-3.

Fuel tank cap



1. Fuel tank cap lock cover
2. Unlock.

To open the fuel tank cap

Open the fuel tank cap lock cover, insert the key, and then turn it 1/4 turn clockwise. The lock will be released and the fuel tank cap can be opened.

To close the fuel tank cap

With the key still inserted, push down the fuel tank cap. Turn the key 1/4 turn counterclockwise, remove it, and then close the lock cover.

TIP

The fuel tank cap cannot be closed unless the key is in the lock. In addition, the key cannot be removed if the cap is not properly closed and locked.

EWA11092

⚠ WARNING

Make sure that the fuel tank cap is properly closed after filling fuel. Leaking fuel is a fire hazard.

Instrument and control functions

Fuel

Make sure there is sufficient gasoline in the tank.

EAU13222

EWA10882

WARNING

Gasoline and gasoline vapors are extremely flammable. To avoid fires and explosions and to reduce the risk of injury when refueling, follow these instructions.

6

1. Before refueling, turn off the engine and be sure that no one is sitting on the vehicle. Never refuel while smoking, or while in the vicinity of sparks, open flames, or other sources of ignition such as the pilot lights of water heaters and clothes dryers.
2. Do not overfill the fuel tank. When refueling, be sure to insert the pump nozzle into the fuel tank filler hole. Stop filling when the fuel reaches the bottom of the filler tube. Because fuel expands when it heats up, heat from the engine or the sun can cause fuel to spill out of the fuel tank.

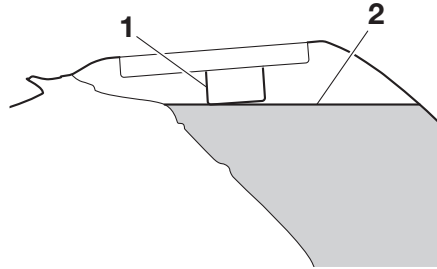

1. Fuel tank filler tube
2. Maximum fuel level

3. Wipe up any spilled fuel immediately. **NOTICE: Immediately wipe off spilled fuel with a clean, dry, soft cloth, since fuel may deteriorate painted surfaces or plastic parts.** [ECA10072]
4. Be sure to securely close the fuel tank cap.

EWA15152

WARNING

Gasoline is poisonous and can cause injury or death. Handle gasoline with care. Never siphon gasoline by mouth. If you should swallow some gasoline or inhale a lot of gasoline vapor, or get some gasoline in your eyes, see your doctor immedi-

ately. If gasoline spills on your skin, wash with soap and water. If gasoline spills on your clothing, change your clothes.

EAU86081

Your Yamaha engine was designed to use unleaded gasoline with a research octane number of 95 or higher. If engine knocking or pinging occurs, use a gasoline of a different brand or higher octane rating.

Recommended fuel:

Unleaded gasoline (E10 acceptable)

Octane number (RON):

95

Fuel tank capacity:

14 L (3.7 US gal, 3.1 Imp.gal)

Fuel tank reserve:

2.5 L (0.66 US gal, 0.55 Imp.gal)

Gasohol

There are two types of gasohol: gasohol containing ethanol and that containing methanol. Gasohol containing ethanol can be used if the ethanol content does not exceed 10% (E10). Gasohol containing methanol is not

recommended by Yamaha because it can cause damage to the fuel system or vehicle performance problems.

ECA11401

NOTICE

Use only unleaded gasoline. The use of leaded gasoline will cause severe damage to internal engine parts, such as the valves and piston rings, as well as to the exhaust system.

Fuel tank overflow hose

EAU86160

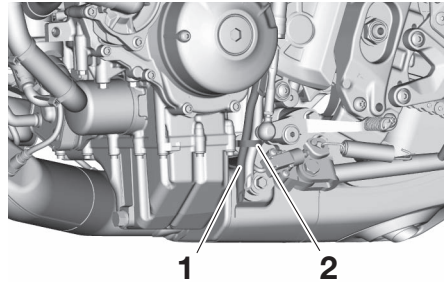

1. Fuel tank overflow hose
2. Clamp

The overflow hose drains excess gasoline and directs it safely away from the vehicle.

Before operating the vehicle:

- Check the fuel tank overflow hose connection.
- Check the fuel tank overflow hose for cracks or damage, and replace it if necessary.
- Make sure that the fuel tank overflow hose is not blocked, and clean it if necessary.
- Make sure that the fuel tank overflow hose is positioned as shown.

TIP

See page 9-10 for canister information.

Instrument and control functions

Catalytic converter

EAU13435

The exhaust system contains catalytic converter(s) to reduce harmful exhaust emissions.

EWA10863

⚠ WARNING

The exhaust system is hot after operation. To prevent a fire hazard or burns:

- Do not park the vehicle near possible fire hazards such as grass or other materials that easily burn.
- Park the vehicle in a place where pedestrians or children are not likely to touch the hot exhaust system.
- Make sure that the exhaust system has cooled down before doing any maintenance work.
- Do not allow the engine to idle more than a few minutes. Long idling can cause a build-up of heat.

Seats

EAUA1812

Passenger seat

To remove the passenger seat

1. Insert the key into the seat lock, and then turn it counterclockwise.

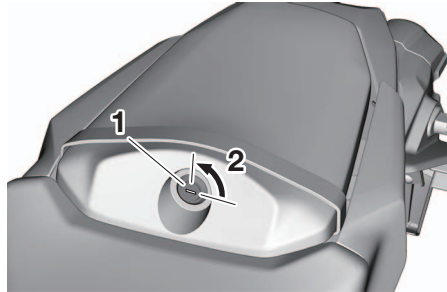

1. Seat lock
2. Unlock.

2. Lift the front of the passenger seat and pull it forward.
3. Remove the key. When removing the key, rotate the key clockwise to the position it was in when inserted.

To install the passenger seat

1. Insert the projections on the front and rear of the passenger seat as shown.

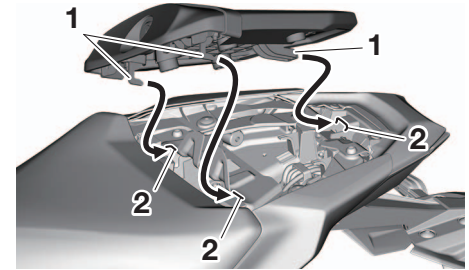

1. Projection
2. Seat holder

2. Insert the key into the seat lock, and then turn it counterclockwise. While holding the key turned in the counterclockwise position, push down on the seat and slide it back in place.
3. Remove the key. When removing the key, rotate the key clockwise to the position it was in when inserted.

Rider seat

To remove the rider seat

1. Remove the passenger seat. (See page 6-41.)
2. Lift the seat rearward and up to remove it.

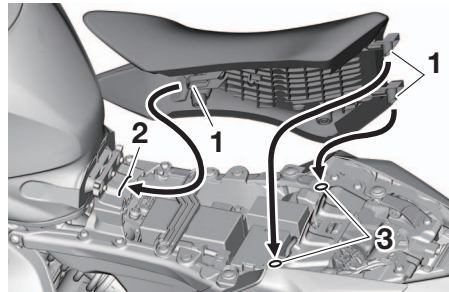
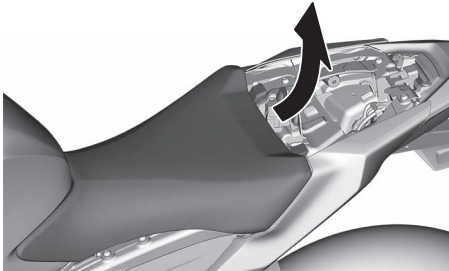

1. Projection
2. Slot
3. Hole

2. Install the passenger seat.

TIP

Make sure that the seats are properly secured before riding.

To install the rider seat

1. Insert the projections on the front of the rider seat into the seat holder and the projections on the rear of the rider seat into the hole on the frame cross member as shown. Place the rider seat in the original position.

Rider footrest position

The rider footrests can be adjusted to one of two positions. From the factory, the footrests are in the low position. Have a Yamaha dealer adjust the positions of the rider footrests.

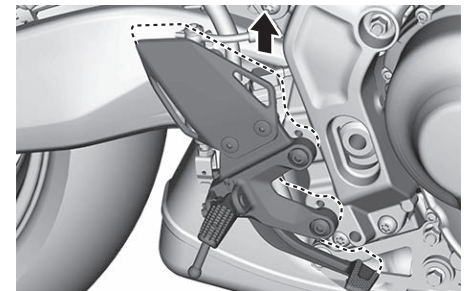
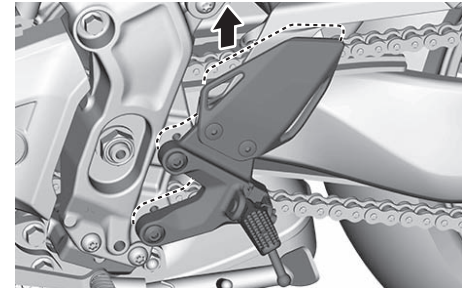

Instrument and control functions

Storage compartment

EAU1850

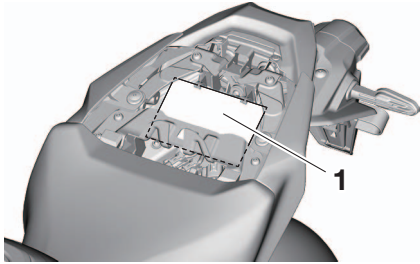

1. Storage compartment

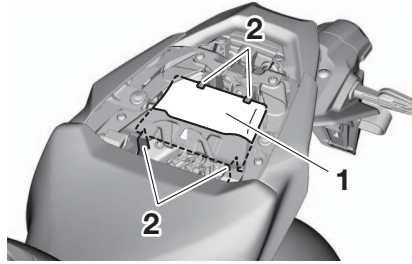

- 1. Plastic bag
- 2. Projection

When storing documents or other items in the storage compartment, secure the plastic bag as shown in the illustration.

EWA15401



WARNING

Do not exceed the maximum load of 168 kg (372 lb) for the vehicle.

Handlebar position

EAU46833

The handlebar can be adjusted to one of two positions to suit the rider's preference. Have a Yamaha dealer adjust the position of the handlebar.

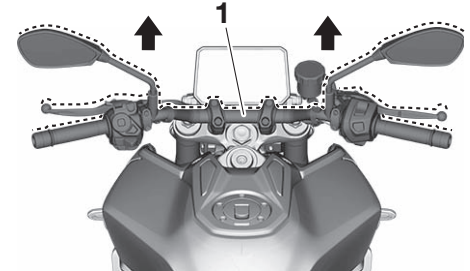

1. Handlebar

6

The storage compartment is located under the passenger seat. (See page 6-41.)

When storing documents or other items in the storage compartment, be sure to wrap them in a plastic bag so that they will not get wet. When washing the vehicle, be careful not to let any water enter the storage compartment.

Adjusting the front fork

EAU76345

EWA14671

WARNING

Always adjust the spring preload on both fork legs equally, otherwise poor handling and loss of stability may result.

Each front fork leg is equipped with a spring preload adjusting bolt, the right front fork leg is equipped with a rebound damping force adjusting screw and the left front fork leg with a compression damping force adjusting screw.

ECA10102

NOTICE

To avoid damaging the mechanism, do not attempt to turn beyond the maximum or minimum settings.

Spring preload

Turn the adjusting bolt in direction (a) to increase the spring preload.

Turn the adjusting bolt in direction (b) to decrease the spring preload.

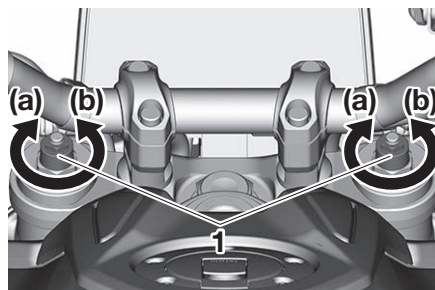

1. Spring preload adjusting bolt

The spring preload setting is determined by measuring distance A, shown in the illustration. The shorter distance A is, the higher the spring preload; the longer distance A is, the lower the spring preload.

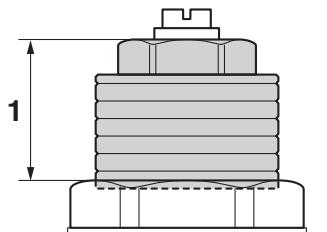

1. Distance A

Spring preload setting:

Minimum (soft):

Distance A = 19.0 mm (0.75 in)

Standard:

Distance A = 16.0 mm (0.63 in)

Maximum (hard):

Distance A = 4.0 mm (0.16 in)

Rebound damping force

The rebound damping force is adjusted on the right fork leg only.

Turn the adjusting screw in direction (a) to increase the rebound damping force.

Turn the adjusting screw in direction (b) to decrease the rebound damping force.

To set the rebound damping force, turn the adjuster in direction (a) until it stops, and then count the clicks in direction (b).

TIP

Be sure to perform this adjustment on the right fork leg.

Instrument and control functions

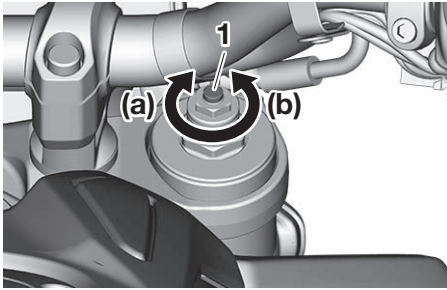

1. Rebound damping force adjusting screw

6

Rebound damping setting:

Minimum (soft):

11 click(s) in direction (b)

Standard:

6 click(s) in direction (b)

Maximum (hard):

1 click(s) in direction (b)

TIP

- When turning the damping force adjuster in direction (a), the 0 click position and the 1 click position may be the same.
- When turning the damping force adjuster in direction (b), it may click beyond the stated specifica-

tions, however such adjustments are ineffective and may damage the suspension.

Compression damping force

The compression damping force is adjusted on the left fork leg only.

Turn the adjusting screw in direction (a) to increase the compression damping force.

Turn the adjusting screw in direction (b) to decrease the compression damping force.

To set the compression damping force, turn the adjuster in direction (a) until it stops, and then count the clicks in direction (b).

TIP

Be sure to perform this adjustment on the left fork leg.

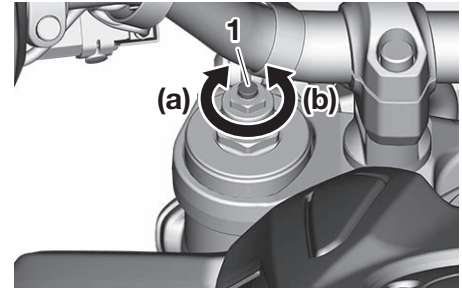

1. Compression damping force adjusting screw

Compression damping setting:

Minimum (soft):

11 click(s) in direction (b)

Standard:

6 click(s) in direction (b)

Maximum (hard):

1 click(s) in direction (b)

TIP

- When turning the damping force adjuster in direction (a), the 0 click position and the 1 click position may be the same.
- When turning the damping force adjuster in direction (b), it may click beyond the stated specifica-

tions, however such adjustments are ineffective and may damage the suspension.

Adjusting the shock absorber assembly

EUAU1821

This shock absorber assembly is equipped with a spring preload adjusting ring and a rebound damping force adjusting screw.

NOTICE

To avoid damaging the mechanism, do not attempt to turn beyond the maximum or minimum settings.

ECA10102

Spring preload

Turn the adjusting ring in direction (a) to increase the spring preload.

Turn the adjusting ring in direction (b) to decrease the spring preload.

Align the appropriate notch in the adjusting ring with the position indicator on the shock absorber.

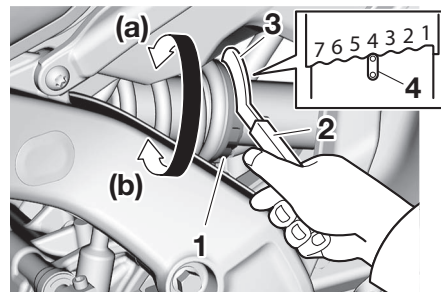

1. Spring preload adjusting ring
2. Extension bar
3. Special wrench
4. Position indicator

TIP

Use the special wrench and extension bar in the tool kit to make this adjustment.

Spring preload setting:

Minimum (soft):

1

Standard:

4

Maximum (hard):

7

Rebound damping force

1. Remove the cap.

Instrument and control functions

2. Turn the adjusting screw in direction (a) to increase the rebound damping force.

Turn the adjusting screw in direction (b) to decrease the rebound damping force.

To set the rebound damping force, turn the adjuster in direction (a) until it stops, and then count the turns in direction (b).

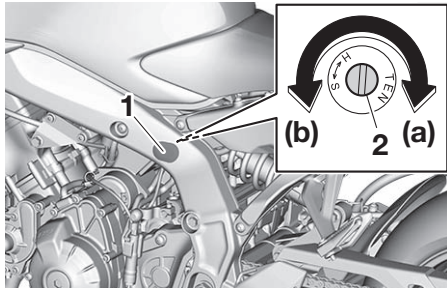

1. Cap
2. Rebound damping force adjusting screw

Rebound damping setting:

- Minimum (soft):
2 1/2 turn(s) in direction (b)
- Standard:
1 turn(s) in direction (b)
- Maximum (hard):
0 turn(s) in direction (b)

TIP

When turning the damping force adjuster in direction (b), it may turn beyond the stated specifications, however such adjustments are ineffective and may damage the suspension.

EWA10222

WARNING

This shock absorber assembly contains highly pressurized nitrogen gas. Read and understand the following information before handling the shock absorber assembly.

- Do not tamper with or attempt to open the cylinder assembly.
- Do not subject the shock absorber assembly to an open flame or other high heat source. This may cause the unit to explode due to excessive gas pressure.
- Do not deform or damage the cylinder in any way. Cylinder damage will result in poor damping performance.

- Do not dispose of a damaged or worn-out shock absorber assembly yourself. Take the shock absorber assembly to a Yamaha dealer for any service.

DC connectors

EAU70642

This vehicle is equipped with additional wiring and DC connector(s) for the installation of optional electric accessories.

Consult a Yamaha dealer for more information regarding the location and capacity of the DC connector(s) and about what accessories are capable of being installed.

USB Type-C jack

EAU1831

This model is equipped with a 5 V 3 A USB Type-C jack. The USB Type-C jack can be used when the main switch is on.

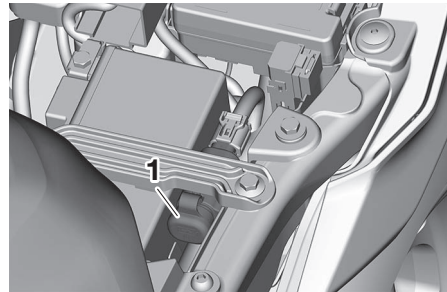

1. USB jack cap

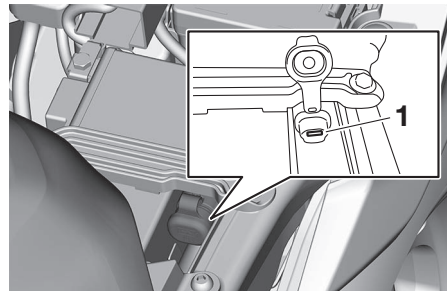

1. USB Type-C jack

TIP

Under some conditions, the device battery level may drop even while the USB is plugged in.

ECA28531

NOTICE

- To protect the USB Type-C jack from water and collisions, install the cap when the jack is not being used.
- To prevent damage, avoid applying excessive force when opening and closing the USB jack cap.
- Ensure the USB jack cap is properly installed and do not use the USB Type-C jack when it rains or when washing the vehicle. If the USB Type-C jack gets wet, please dry it with the vehicle turned off before using it.
- Do not put tension or apply force to cables attached to the USB Type-C jack as it may cause damage.

Instrument and control functions

Sidestand

EAU15306

The sidestand is located on the left side of the frame. Raise the sidestand or lower it with your foot while holding the vehicle upright.

TIP

The built-in sidestand switch is part of the ignition circuit cut-off system, which cuts the ignition in certain situations. (See the following section for an explanation of the ignition circuit cut-off system.)

EWA10242

WARNING

The vehicle must not be ridden with the sidestand down, or if the sidestand cannot be properly moved up (or does not stay up), otherwise the sidestand could contact the ground and distract the operator, resulting in a possible loss of control. Yamaha's ignition circuit cut-off system has been designed to assist the operator in fulfilling the responsibility of raising the sidestand before starting off. Therefore, check

this system regularly and have a Yamaha dealer repair it if it does not function properly.

EAU57952

Ignition circuit cut-off system

This system prevents in-gear engine starts unless the clutch lever is pulled and the sidestand is up. Also, it will stop the running engine should the sidestand be lowered while the transmission is in gear.

Periodically check this system via the following procedure.

TIP

- This check is most reliable if performed with a warmed-up engine.
 - See pages 6-2 and 6-3 for switch operation information.
-

Instrument and control functions

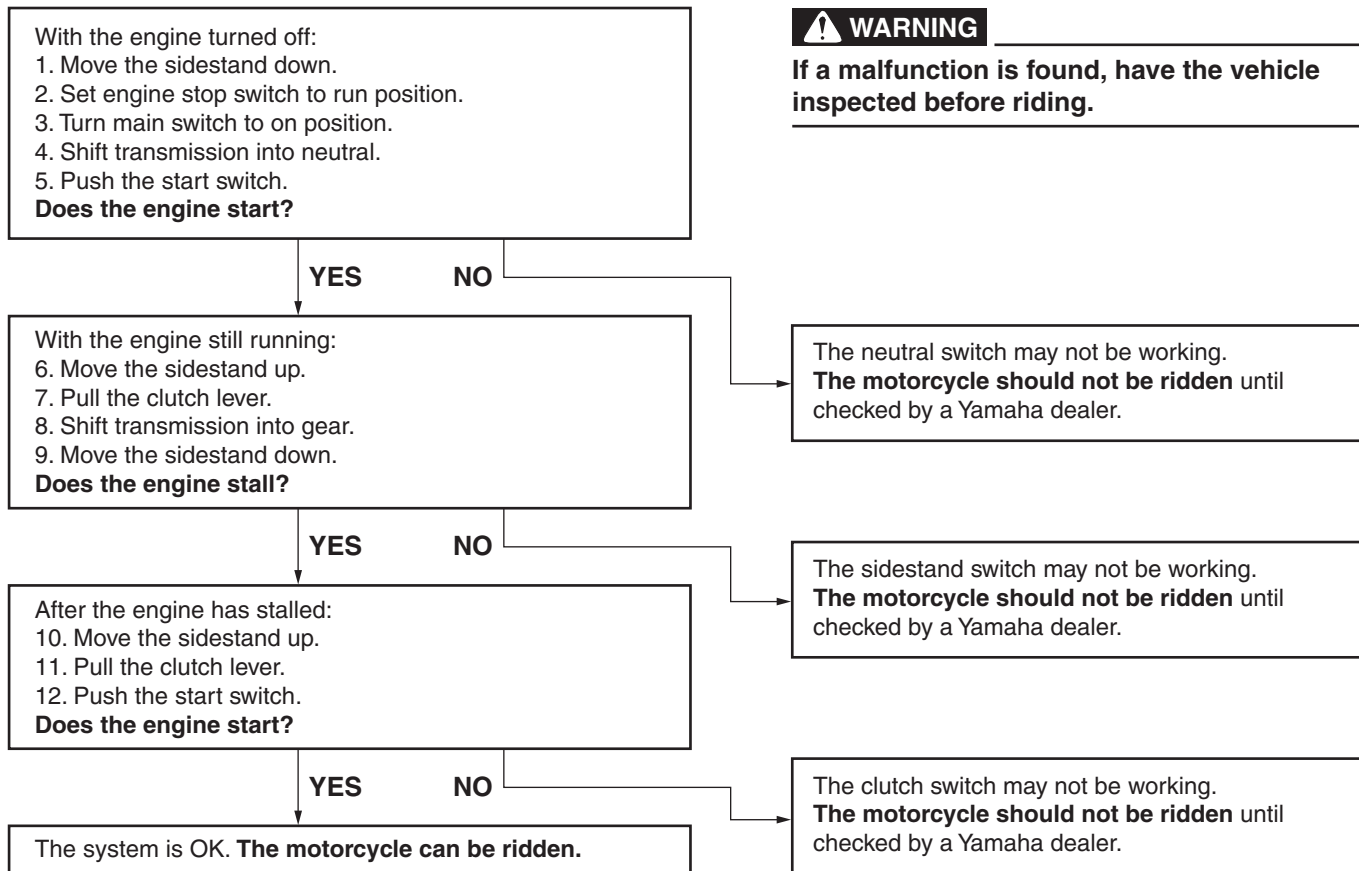

For your safety – pre-operation checks

EAU1559B

Inspect your vehicle each time you use it to make sure the vehicle is in safe operating condition. Always follow the inspection and maintenance procedures and schedules described in the Owner's Manual.

EWA11152

WARNING

Failure to inspect or maintain the vehicle properly increases the possibility of an accident or equipment damage. Do not operate the vehicle if you find any problem. If a problem cannot be corrected by the procedures provided in this manual, have the vehicle inspected by a Yamaha dealer.

Before using this vehicle, check the following points:

ITEM	CHECKS	PAGE
Fuel	<ul style="list-style-type: none">• Check fuel level in fuel tank.• Refuel if necessary.• Check fuel line for leakage.• Check fuel tank overflow hose for obstructions, cracks or damage, and check hose connection.	6-39, 6-40
Engine oil	<ul style="list-style-type: none">• Check oil level in engine.• If necessary, add recommended oil to specified level.• Check vehicle for oil leakage.	9-10
Coolant	<ul style="list-style-type: none">• Check coolant level in reservoir.• If necessary, add recommended coolant to specified level.• Check cooling system for leakage.	9-13
Front brake	<ul style="list-style-type: none">• Check operation.• If soft or spongy, have Yamaha dealer bleed hydraulic system.• Check brake pads for wear.• Replace if necessary.• Check fluid level in reservoir.• If necessary, add specified brake fluid to specified level.• Check hydraulic system for leakage.	9-20, 9-20

For your safety – pre-operation checks

ITEM	CHECKS	PAGE
Rear brake	<ul style="list-style-type: none"> • Check operation. • If soft or spongy, have Yamaha dealer bleed hydraulic system. • Check brake pads for wear. • Replace if necessary. • Check fluid level in reservoir. • If necessary, add specified brake fluid to specified level. • Check hydraulic system for leakage. 	9-20, 9-20
Clutch	<ul style="list-style-type: none"> • Check operation. • Lubricate cable if necessary. • Check lever free play. • Adjust if necessary. 	9-18
Throttle grip	<ul style="list-style-type: none"> • Check for smooth rotation and automatic return. 	9-25
Control cables	<ul style="list-style-type: none"> • Make sure that operation is smooth. • Lubricate if necessary. 	9-25
Drive chain	<ul style="list-style-type: none"> • Check chain slack. • Adjust if necessary. • Check chain condition. • Lubricate if necessary. 	9-22, 9-24
Wheels and tires	<ul style="list-style-type: none"> • Check for damage. • Check tire condition and tread depth. • Check air pressure. • Correct if necessary. 	9-15, 9-17
Brake and shift pedals	<ul style="list-style-type: none"> • Make sure that operation is smooth. • Lubricate pedal pivoting points if necessary. 	9-25
Brake and clutch levers	<ul style="list-style-type: none"> • Make sure that operation is smooth. • Lubricate lever pivoting points if necessary. 	9-26
Sidestand	<ul style="list-style-type: none"> • Make sure that operation is smooth. • Lubricate pivot if necessary. 	9-27
Chassis fasteners	<ul style="list-style-type: none"> • Make sure that all nuts, bolts and screws are properly tightened. • Tighten if necessary. 	—

For your safety – pre-operation checks

ITEM	CHECKS	PAGE
Instruments, lights, signals and switches	<ul style="list-style-type: none">• Check operation.• Correct if necessary.	–
Sidestand switch	<ul style="list-style-type: none">• Check operation of ignition circuit cut-off system.• If system is not working correctly, have Yamaha dealer check vehicle.	6-49

EAU15952

Read the Owner's Manual carefully to become familiar with all controls. If there is a control or function you do not understand, ask your Yamaha dealer.

EWA10272



Failure to familiarize yourself with the controls can lead to loss of control, which could cause an accident or injury.

EAU16842

Engine break-in

There is never a more important period in the life of your engine than the period between 0 and 1600 km (1000 mi). For this reason, you should read the following material carefully.

Since the engine is brand new, do not put an excessive load on it for the first 1600 km (1000 mi). The various parts in the engine wear and polish themselves to the correct operating clearances. During this period, prolonged full-throttle operation or any condition that might result in engine overheating must be avoided.

EAU17094

0–1000 km (0–600 mi)

Avoid prolonged operation above 5300 r/min. **NOTICE: After 1000 km (600 mi) of operation, the engine oil must be changed and the oil filter cartridge or element replaced.** [ECA10303]

1000–1600 km (600–1000 mi)

Avoid prolonged operation above 6300 r/min.

1600 km (1000 mi) and beyond

The vehicle can now be operated normally.

ECA10311

NOTICE

- **Keep the engine speed out of the tachometer red zone.**
- **If any engine trouble should occur during the engine break-in period, immediately have a Yamaha dealer check the vehicle.**

Operation and important riding points

Starting the engine

EAU91811

The ignition circuit cut-off system will enable starting when:

- the transmission is in the neutral position or
- the transmission is in gear, the sidestand is up, and the clutch lever is pulled.

To start the engine

1. Turn the main switch on and set the engine stop switch to the run position.
2. Confirm the indicator and warning light(s) come on for a few seconds, and then go off. (See page 6-5.)

TIP

- Do not start the engine if the engine trouble warning light remains on.
- The oil pressure and coolant temperature warning light should come on and stay on until the engine is started.

- The ABS warning light should come on and stay on until the vehicle reaches a speed of 5 km/h (3 mi/h).

ECA24110

NOTICE

If a warning or indicator light does not work as described above, have a Yamaha dealer check the vehicle.

3. Shift the transmission into the neutral position.
4. Start the engine by pushing the start switch.
5. Release the start switch when the engine starts, or after 5 seconds. Wait 10 seconds before pressing the switch again to allow battery voltage to restore.

TIP

If the engine fails to start, try again with the throttle grip turned by a 1/4 turn (20 degrees) open.

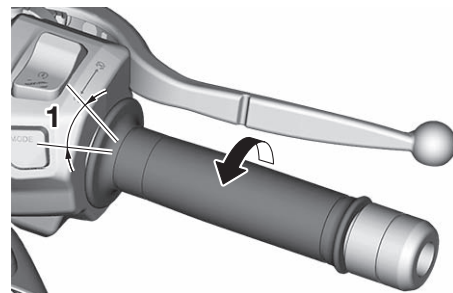

1. 1/4 turn (20 degrees)

ECA11043

NOTICE

For maximum engine life, never accelerate hard when the engine is cold!

EAU68221

EAU91544

ECA22523

TIP

This model is equipped with:

- an inertial measurement unit (IMU). This unit stops the engine in case of a turnover. Turn the main switch off and then on before attempting to restart the engine. Failing to do so will prevent the engine from starting even though the engine will crank when pushing the start switch.
- an engine auto-stop system. The engine stops automatically if left idling for 20 minutes. If the engine stops, simply push the start switch to restart the engine.

Shifting

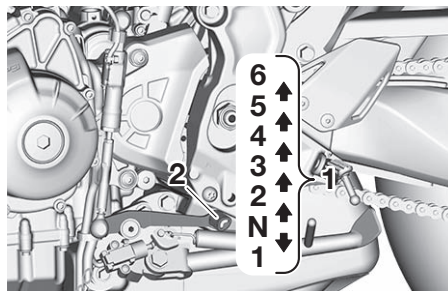

1. Gear positions
2. Shift pedal

Shifting gears lets you control the amount of engine power available for starting off, accelerating, climbing hills, etc. The gear positions are shown in the illustration.

TIP

- To shift the transmission into the neutral position (N), press the shift pedal down repeatedly until it reaches the end of its travel, and then slightly raise it.
- This model is equipped with a quick shifter. (See page 4-3.)

NOTICE

- When shifting, press the shift pedal firmly until you feel the gear shift is complete.
- Even with the transmission in the neutral position, do not coast for long periods of time with the engine off, nor tow the motorcycle for long distances. The transmission is properly lubricated only when the engine is running. Inadequate lubrication may damage the transmission.
- Except when using the quick shifter, always pull the clutch lever when changing gears to avoid damaging the engine, transmission, and drivetrain.

EAU85370

To start out and accelerate

1. Pull the clutch lever to disengage the clutch.
2. Shift the transmission into first gear. The neutral indicator light should go out.

Operation and important riding points

3. Open the throttle gradually, and at the same time, release the clutch lever slowly.
4. After starting out, close the throttle, and at the same time, quickly pull the clutch lever in.
5. Shift the transmission into second gear. (Make sure not to shift the transmission into the neutral position.)
6. Open the throttle part way and gradually release the clutch lever.
7. Follow the same procedure when shifting to the next higher gear.

EAU85380

8

To decelerate

1. Release the throttle and apply both the front and the rear brakes smoothly to slow the motorcycle.
2. As the vehicle decelerates, shift to a lower gear.
3. When the engine is about to stall or runs roughly, pull the clutch lever in, use the brakes to slow the motorcycle, and continue to downshift as necessary.

4. Once the motorcycle has stopped, the transmission can be shifted into the neutral position. The neutral indicator light should come on and then the clutch lever can be released.

EWA17380



- **Improper braking can cause loss of control or traction. Always use both brakes and apply them smoothly.**
 - **Make sure that the motorcycle and the engine have sufficiently slowed before shifting to a lower gear. Engaging a lower gear when the vehicle or engine speed is too high could make the rear wheel lose traction or the engine to over-rev. This could cause loss of control, an accident and injury. It could also cause engine or drive train damage.**
-

EAU16811

Tips for reducing fuel consumption

Fuel consumption depends largely on your riding style. Consider the following tips to reduce fuel consumption:

- Shift up swiftly, and avoid high engine speeds during acceleration.
- Do not rev the engine while shifting down, and avoid high engine speeds with no load on the engine.
- Turn the engine off instead of letting it idle for an extended length of time (e.g., in traffic jams, at traffic lights or at railroad crossings).

EAU17214

Parking

When parking, stop the engine, and then remove the key from the main switch.

EWA10312

WARNING

- **Since the engine and exhaust system can become very hot, park in a place where pedestrians or children are not likely to touch them and be burned.**
 - **Do not park on a slope or on soft ground, otherwise the vehicle may overturn, increasing the risk of a fuel leak and fire.**
 - **Do not park near grass or other flammable materials which might catch fire.**
-

Periodic maintenance and adjustment

EAU17246

EWA15123

EAU17303

Periodic inspection, adjustment, and lubrication will keep your vehicle in the safest and most efficient condition possible. Safety is an obligation of the vehicle owner/operator. The most important points of vehicle inspection, adjustment, and lubrication are explained on the following pages.

The intervals given in the periodic maintenance charts should be simply considered as a general guide under normal riding conditions. However, depending on the weather, terrain, geographical location, and individual use, the maintenance intervals may need to be shortened.

9

WARNING

EWA10322

Failure to properly maintain the vehicle or performing maintenance activities incorrectly may increase your risk of injury or death during service or while using the vehicle. If you are not familiar with vehicle service, have a Yamaha dealer perform service.

WARNING

Turn off the engine when performing maintenance unless otherwise specified.

- **A running engine has moving parts that can catch on body parts or clothing and electrical parts that can cause shocks or fires.**
 - **Running the engine while servicing can lead to eye injury, burns, fire, or carbon monoxide poisoning – possibly leading to death. See page 2-3 for more information about carbon monoxide.**
-

WARNING

EWA15461

Brake discs, calipers, drums, and linings can become very hot during use. To avoid possible burns, let brake components cool before touching them.

Emission controls not only function to ensure cleaner air, but are also vital to proper engine operation and maximum performance. In the following periodic maintenance charts, the services related to emissions control are grouped separately. These services require specialized data, knowledge, and equipment. Maintenance, replacement, or repair of the emission control devices and systems may be performed by any repair establishment or individual that is certified (if applicable). Yamaha dealers are trained and equipped to perform these particular services.

EAU94590

Tool kit

The tool kit should be stored separately from the vehicle.

The information included in this manual and the tools provided are intended to assist you in the performance of preventive maintenance and minor repairs. However, a torque wrench and other tools are necessary to perform certain maintenance work correctly.

TIP _____

If you do not have the tools or experience required for a particular job, have your Yamaha dealer perform it for you.

Periodic maintenance and adjustment

EAU71033

Periodic maintenance charts

TIP

- Items marked with an asterisk should be performed by your Yamaha dealer because these items require special tools, data, and technical skills.
- From 50000 km (30000 mi), repeat the maintenance intervals starting from 10000 km (6000 mi).
- **The annual checks must be performed every year, except if a distance-based maintenance is performed instead.**

EAU71052

Periodic maintenance chart for the emission control system

NO.	ITEM	CHECK OR MAINTENANCE JOB	ODOMETER READING					ANNUAL CHECK
			1000 km (600 mi)	10000 km (6000 mi)	20000 km (12000 mi)	30000 km (18000 mi)	40000 km (24000 mi)	
1	* Fuel line	<ul style="list-style-type: none"> • Check fuel hoses for cracks or damage. • Replace if necessary. 		√	√	√	√	√
2	* Spark plugs	<ul style="list-style-type: none"> • Check condition. • Adjust gap and clean. 		√		√		
		<ul style="list-style-type: none"> • Replace. 			√		√	
3	* Valve clearance	<ul style="list-style-type: none"> • Check and adjust. 	Every 40000 km (24000 mi)					
4	* Fuel injection	<ul style="list-style-type: none"> • Check engine idle speed. 	√	√	√	√	√	√
		<ul style="list-style-type: none"> • Check and adjust synchronization. 		√	√	√	√	√
5	* Exhaust system	<ul style="list-style-type: none"> • Check for leakage. • Tighten if necessary. • Replace gaskets if necessary. 	√	√	√	√	√	

Periodic maintenance and adjustment

NO.	ITEM	CHECK OR MAINTENANCE JOB	ODOMETER READING					ANNUAL CHECK
			1000 km (600 mi)	10000 km (6000 mi)	20000 km (12000 mi)	30000 km (18000 mi)	40000 km (24000 mi)	
6	*	Evaporative emission control system			√		√	

Periodic maintenance and adjustment

EAU71354

General maintenance and lubrication chart

NO.	ITEM	CHECK OR MAINTENANCE JOB	ODOMETER READING					ANNUAL CHECK
			1000 km (600 mi)	10000 km (6000 mi)	20000 km (12000 mi)	30000 km (18000 mi)	40000 km (24000 mi)	
1	* Diagnostic system check	<ul style="list-style-type: none"> Perform dynamic inspection using Yamaha diagnostic tool. Check the error codes. 	√	√	√	√	√	√
2	* Air filter element	<ul style="list-style-type: none"> Replace. 	Every 40000 km (24000 mi)					
3	Clutch	<ul style="list-style-type: none"> Check operation. Adjust. 	√	√	√	√	√	
4	* Front brake	<ul style="list-style-type: none"> Check operation, fluid level, and for fluid leakage. Replace brake pads if necessary. 	√	√	√	√	√	√
5	* Rear brake	<ul style="list-style-type: none"> Check operation, fluid level, and for fluid leakage. Replace brake pads if necessary. 	√	√	√	√	√	√
6	* Brake hoses	<ul style="list-style-type: none"> Check for cracks or damage. 		√	√	√	√	√
		<ul style="list-style-type: none"> Replace. 	Every 4 years					
7	* Brake fluid	<ul style="list-style-type: none"> Change. 	Every 2 years					
8	* Wheels	<ul style="list-style-type: none"> Check runout and for damage. Replace if necessary. 		√	√	√	√	
9	* Tires	<ul style="list-style-type: none"> Check tread depth and for damage. Replace if necessary. Check air pressure. Correct if necessary. 		√	√	√	√	√
10	* Wheel bearings	<ul style="list-style-type: none"> Check bearing for looseness or damage. 		√	√	√	√	

Periodic maintenance and adjustment

NO.	ITEM	CHECK OR MAINTENANCE JOB	ODOMETER READING					ANNUAL CHECK
			1000 km (600 mi)	10000 km (6000 mi)	20000 km (12000 mi)	30000 km (18000 mi)	40000 km (24000 mi)	
11	* Swingarm pivot bearings	• Check operation and for excessive play.		√	√	√	√	
		• Lubricate with lithium-soap-based grease.	Every 50000 km (30000 mi)					
12	Drive chain	<ul style="list-style-type: none"> • Check chain slack, alignment and condition. • Adjust and lubricate chain with a special O-ring chain lubricant thoroughly. 	Every 1000 km (600 mi) and after washing the motorcycle, riding in the rain or riding in wet areas					
13	* Steering bearings	• Check bearing assemblies for looseness.	√	√		√		
		• Moderately repack with lithium-soap-based grease.			√		√	
14	* Chassis fasteners	• Make sure that all nuts, bolts and screws are properly tightened.		√	√	√	√	√
15	Brake lever pivot shaft	• Lubricate with silicone grease.		√	√	√	√	√
16	Brake pedal pivot shaft	• Lubricate with lithium-soap-based grease.		√	√	√	√	√
17	Clutch lever pivot shaft	• Lubricate with lithium-soap-based grease.		√	√	√	√	√
18	Shift pedal pivot shaft	• Lubricate with lithium-soap-based grease.		√	√	√	√	√
19	Sidestand	<ul style="list-style-type: none"> • Check operation. • Lubricate with molybdenum disulfide grease. 		√	√	√	√	√

Periodic maintenance and adjustment

NO.	ITEM	CHECK OR MAINTENANCE JOB	ODOMETER READING					ANNUAL CHECK
			1000 km (600 mi)	10000 km (6000 mi)	20000 km (12000 mi)	30000 km (18000 mi)	40000 km (24000 mi)	
20	* Sidestand switch	<ul style="list-style-type: none"> Check operation and replace if necessary. 	√	√	√	√	√	√
21	* Front fork	<ul style="list-style-type: none"> Check operation and for oil leakage. Replace if necessary. 		√	√	√	√	
22	* Shock absorber assembly	<ul style="list-style-type: none"> Check operation and for oil leakage. Replace if necessary. 		√	√	√	√	
23	* Rear suspension relay arm and connecting arm pivoting points	<ul style="list-style-type: none"> Check operation. 		√	√	√	√	
		<ul style="list-style-type: none"> Lubricate with lithium-soap-based grease. 			√		√	
24	Engine oil	<ul style="list-style-type: none"> Change (warm engine before draining). Check oil level and vehicle for oil leakage. 	√	√	√	√	√	√
25	Engine oil filter cartridge	<ul style="list-style-type: none"> Replace. 	√		√		√	
26	* Cooling system	<ul style="list-style-type: none"> Check coolant level and vehicle for coolant leakage. 		√	√	√	√	√
		<ul style="list-style-type: none"> Change. 	Every 3 years					
27	* Front and rear brake switches	<ul style="list-style-type: none"> Check operation. 	√	√	√	√	√	√
28	* Moving parts and cables	<ul style="list-style-type: none"> Lubricate. 		√	√	√	√	√
29	* Throttle grip	<ul style="list-style-type: none"> Check operation. Lubricate throttle grip housing tube guides. 		√	√	√	√	√

Periodic maintenance and adjustment

NO.	ITEM	CHECK OR MAINTENANCE JOB	ODOMETER READING					ANNUAL CHECK
			1000 km (600 mi)	10000 km (6000 mi)	20000 km (12000 mi)	30000 km (18000 mi)	40000 km (24000 mi)	
30	* Lights, signals and switches	<ul style="list-style-type: none"> • Check operation. • Adjust headlight beam. 	√	√	√	√	√	√

EAU72800

TIP

- Air filter
 - This model's air filter is equipped with a disposable oil-coated paper element, which must not be cleaned with compressed air to avoid damaging it.
 - The air filter element needs to be replaced more frequently when riding in unusually wet or dusty areas.
- Hydraulic brake service
 - Regularly check and, if necessary, correct the brake fluid level.
 - Every two years replace the internal components of the brake master cylinders and calipers, and change the brake fluid.
 - Replace the brake hoses every four years and if cracked or damaged.

Periodic maintenance and adjustment

EAU19653

Checking the spark plugs

The spark plugs are important engine components, which should be checked periodically, preferably by a Yamaha dealer. Since heat and deposits will cause any spark plug to slowly erode, they should be removed and checked in accordance with the periodic maintenance and lubrication chart. In addition, the condition of the spark plugs can reveal the condition of the engine.

The porcelain insulator around the center electrode of each spark plug should be a medium-to-light tan (the ideal color when the vehicle is ridden normally), and all spark plugs installed in the engine should have the same color. If any spark plug shows a distinctly different color, the engine could be operating improperly. Do not attempt to diagnose such problems yourself. Instead, have a Yamaha dealer check the vehicle.

If a spark plug shows signs of electrode erosion and excessive carbon or other deposits, it should be replaced.

Specified spark plug:
NGK/LMAR9A-9

Before installing a spark plug, the spark plug gap should be measured with a wire thickness gauge and, if necessary, adjusted to specification.

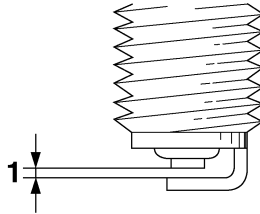

1. Spark plug gap

Spark plug gap:
0.8–0.9 mm (0.031–0.035 in)

Clean the surface of the spark plug gasket and its mating surface, and then wipe off any grime from the spark plug threads.

Tightening torque:
Spark plug:
13 N·m (1.3 kgf·m, 9.6 lb·ft)

TIP

If a torque wrench is not available when installing a spark plug, a good estimate of the correct torque is 1/4–1/2 turn past finger tight. However, the spark plug should be tightened to the specified torque as soon as possible.

ECA10841

NOTICE

Do not use any tools to remove or install the spark plug cap, otherwise the ignition coil coupler may get damaged. The spark plug cap may be difficult to remove because the rubber seal on the end of the cap fits tightly. To remove the spark plug cap, simply twist it back and forth while pulling it out; to install it, twist it back and forth while pushing it in.

Canister

EAU36113

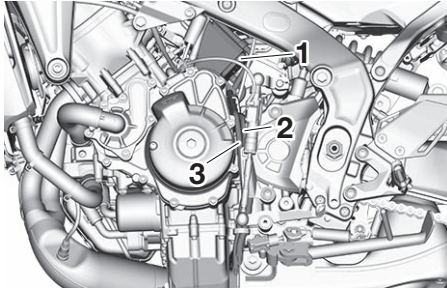

1. Canister
2. Canister breather hose
3. Fuel tank overflow hose

This model is equipped with a canister to prevent the discharging of fuel vapor into the atmosphere. Before operating this vehicle, make sure to check the following:

- Check each hose connection.
- Check each hose and canister for cracks or damage. Replace if damaged.
- Make sure that the canister breather is not blocked, and if necessary, clean it.

Engine oil

EAU1990H

The engine oil level should be checked regularly. In addition, the oil must be changed and the oil filter cartridge replaced at the intervals specified in the periodic maintenance chart.

Recommended engine oil:

See page 11-1.

Oil quantity:

Oil change:

2.80 L (2.96 US qt, 2.46 Imp.qt)

With oil filter removal:

3.20 L (3.38 US qt, 2.82 Imp.qt)

ECA11621

NOTICE

- In order to prevent clutch slippage (since the engine oil also lubricates the clutch), do not mix any chemical additives. Do not use oils with a diesel specification of “CD” or oils of a higher quality than specified. In addition, do not use oils labeled “ENERGY CONSERVING II” or higher.
- Make sure that no foreign material enters the crankcase.

To check the engine oil level

1. Start the engine, warm it up for several minutes, and then turn it off.
2. Wait a few minutes until the oil level settles and with the vehicle on a level surface, hold it upright for an accurate reading.
3. Look at the check window located at the bottom-right side of the crankcase.

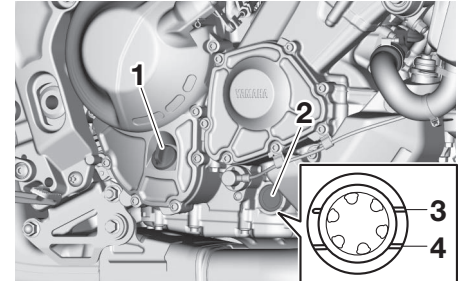

1. Engine oil filler cap
2. Engine oil level check window
3. Maximum level mark
4. Minimum level mark

TIP

The engine oil should be between the minimum and maximum level marks.

Periodic maintenance and adjustment

- If the engine oil is at or below the minimum level mark, remove the oil filler cap and add oil.
- Check the engine oil filler cap O-ring. Replace if damaged.

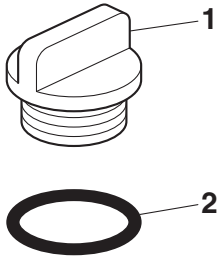

- Engine oil filler cap
- O-ring

- Install the engine oil filler cap.

To change the engine oil (and filter)

- Start the engine and allow it to idle for a few minutes to warm up the oil, and then stop the engine.
- Place an oil pan under the engine to collect the used oil.
- Remove the engine oil filler cap, and then the engine oil drain bolt and gasket.

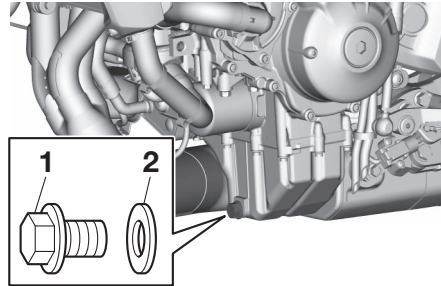

- Engine oil drain bolt
- Gasket

TIP

Skip steps 4–6 if the oil filter cartridge is not being replaced.

- Remove the oil filter cartridge with an oil filter wrench.

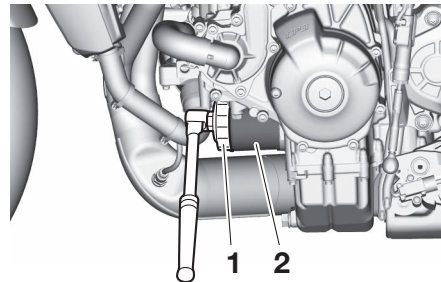

- Oil filter wrench
- Oil filter cartridge

TIP

An oil filter wrench is available at a Yamaha dealer.

- Apply a thin coat of clean engine oil to the O-ring of the new oil filter cartridge.

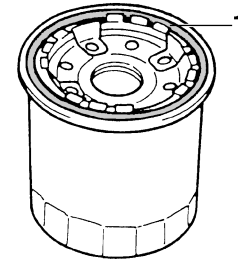

- O-ring

TIP

Make sure that the O-ring is properly seated.

- Install the new oil filter cartridge, and then tighten to the specified torque.

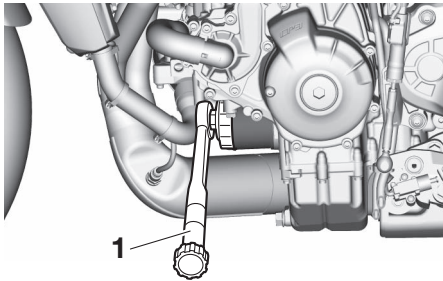

1. Torque wrench

Tightening torque:

Oil filter cartridge:
17 N·m (1.7 kgf·m, 13 lb·ft)

7. Install the engine oil drain bolt with a new gasket, and then tighten the bolt to the specified torque.

Tightening torque:

Engine oil drain bolt:
43 N·m (4.3 kgf·m, 32 lb·ft)

8. Pour the specified amount of the recommended oil into the crankcase.

TIP _____

Using a funnel is recommended.

9. After checking the engine oil filler cap O-ring, install the filler cap.

TIP _____

Wipe off any spilled oil before starting the engine.

10. Start the engine and let it idle while checking for oil leaks.

TIP _____

If any oil leaks are found which you cannot fix, have the vehicle inspected.

11. Stop the engine, wait a few minutes for the oil level to settle, and then check the oil level one last time. **NOTICE: Do not operate the vehicle until you know that the engine oil level is sufficient.**

[ECA10012]

Why Yamalube

YAMALUBE oil is a Genuine YAMAHA Part born of the engineers' passion and belief that engine oil is an important liquid engine component. We form teams of specialists in the fields of mechanical engineering, chemistry, electronics and track testing, and have them develop the engine together with the oil it will use. Yamalube oils take full advantage of the base oil's qualities and blend in the ideal balance of additives to make sure the final oil clears our performance standards. Thus, Yamalube mineral, semisynthetic and synthetic oils have their own distinct characters and value. Yamaha's experience gained over many years of research and development into oil since the 1960's helps make Yamalube the best choice for your Yamaha engine.



Periodic maintenance and adjustment

Coolant

EAU51203

The coolant level should be checked regularly. In addition, the coolant must be changed at the intervals specified in the periodic maintenance chart.

Recommended coolant:

YAMALUBE coolant

Coolant quantity:

Coolant reservoir (max level mark):
0.28 L (0.30 US qt, 0.25 Imp.qt)

Radiator (including all routes):
1.72 L (1.82 US qt, 1.51 Imp.qt)

TIP

If genuine Yamaha coolant is not available, use an ethylene glycol antifreeze containing corrosion inhibitors for aluminum engines and mix with distilled water at a 1:1 ratio.

EAU20097

To check the coolant level

Since the coolant level varies with engine temperature, check when the engine is cold.

1. Park the vehicle on a level surface.

2. With the vehicle in an upright position, look at the coolant level in the reservoir.

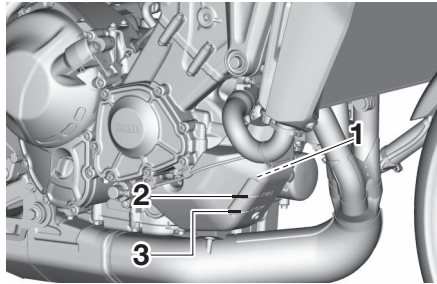

1. Coolant reservoir
2. Maximum level mark
3. Minimum level mark

3. If the coolant is at or below the minimum level mark, remove the coolant reservoir cap. **WARNING! Remove only the coolant reservoir cap. Never attempt to remove the radiator cap when the engine is hot.** [EWA15162]

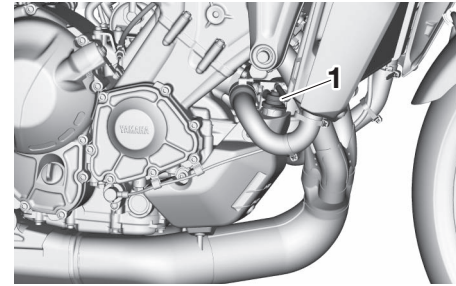

1. Coolant reservoir cap

4. Add coolant to the maximum level mark. **NOTICE: If coolant is not available, use distilled water or soft tap water instead. Do not use hard water or salt water since it is harmful to the engine. If water has been used instead of coolant, replace it with coolant as soon as possible, otherwise the cooling system will not be protected against frost and corrosion. If water has been added to the coolant, have a Yamaha dealer check the anti-freeze content of the coolant as soon as possible, otherwise the effectiveness of the coolant will be reduced.** [ECA10473]

Periodic maintenance and adjustment

5. Install the coolant reservoir cap.

Changing the coolant

EAU33032

The coolant must be changed at the intervals specified in the periodic maintenance and lubrication chart. Have a Yamaha dealer change the coolant.

WARNING! Never attempt to remove the radiator cap when the engine is hot. [EWA10382]

Air filter element

EAU36765

The air filter element must be replaced at the intervals specified in the periodic maintenance and lubrication chart. Have a Yamaha dealer replace the air filter element.

Checking the engine idling speed

EAU44735

Check the engine idling speed and, if necessary, have it corrected by a Yamaha dealer.

Engine idling speed:
1200–1400 r/min

Periodic maintenance and adjustment

Valve clearance

EAU21403

The valves are an important engine component, and since valve clearance changes with use, they must be checked and adjusted at the intervals specified in the periodic maintenance chart. Unadjusted valves can result in improper air-fuel mixture, engine noise, and eventually engine damage. To prevent this from occurring, have your Yamaha dealer check and adjust the valve clearance at regular intervals.

TIP

This service must be performed when the engine is cold.

Tires

EAU64412

Tires are the only contact between the vehicle and the road. Safety in all conditions of riding depends on a relatively small area of road contact. Therefore, it is essential to maintain the tires in good condition at all times and replace them at the appropriate time with the specified tires.

Tire air pressure

The tire air pressure should be checked and, if necessary, adjusted before each ride.

EWA10504



WARNING

Operation of this vehicle with improper tire pressure may cause severe injury or death from loss of control.

- The tire air pressure must be checked and adjusted on cold tires (i.e., when the temperature of the tires equals the ambient temperature).
- The tire air pressure must be adjusted in accordance with the riding speed and with the total

weight of rider, passenger, cargo, and accessories approved for this model.

Cold tire air pressure:

1 person:

Front:

250 kPa (2.50 kgf/cm², 36 psi)

Rear:

290 kPa (2.90 kgf/cm², 42 psi)

2 persons:

Front:

250 kPa (2.50 kgf/cm², 36 psi)

Rear:

290 kPa (2.90 kgf/cm², 42 psi)

Maximum load:

Vehicle:

168 kg (372 lb)

The vehicle's maximum load is the combined weight of the rider, passenger, cargo, and any accessories.

EWA10512



WARNING

Never overload your vehicle. Operation of an overloaded vehicle could cause an accident.

Periodic maintenance and adjustment

Tire inspection

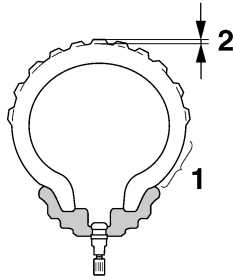

1. Tire sidewall
2. Tire tread depth

The tires must be checked before each ride. If the center tread depth reaches the specified limit, if the tire has a nail or glass fragments in it, or if the sidewall is cracked, have a Yamaha dealer replace the tire immediately.

Minimum tire tread depth (front and rear):
1.5 mm (0.06 in)

TIP

The tire tread depth limits may differ from country to country. Always comply with the local regulations.

⚠ WARNING

EWA10472

- Have a Yamaha dealer replace excessively worn tires. Besides being illegal, operating the vehicle with excessively worn tires decreases riding stability and can lead to loss of control.
- The replacement of all wheel and brake-related parts, including the tires, should be left to a Yamaha dealer, who has the necessary professional knowledge and experience to do so.
- Ride at moderate speeds after changing a tire since the tire surface must first be “broken in” for it to develop its optimal characteristics.

Tire information

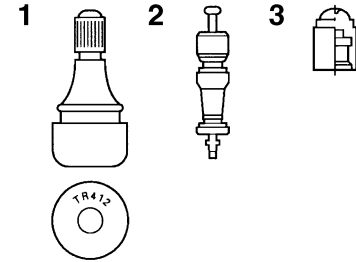

1. Tire air valve
2. Tire air valve core
3. Tire air valve cap with seal

This model is equipped with tubeless tires and tire air valves. Tires age, even if they have not been used or have only been used occasionally. Cracking of the tread and sidewall rubber, sometimes accompanied by carcass deformation, is an evidence of ageing. Old and aged tires shall be checked by tire specialists to ascertain their suitability for further use.

EWA10902

⚠ WARNING

- The front and rear tires should be of the same make and design, otherwise the handling

Periodic maintenance and adjustment

characteristics of the motorcycle may be different, which could lead to an accident.

- Always make sure that the valve caps are securely installed to prevent air pressure leakage.
- Use only the tire valves and valve cores listed below to avoid tire deflation during a ride.

After extensive tests, only the tires listed below have been approved for this model by Yamaha.

Front tire:

Size:

120/70ZR17M/C (58W)

Manufacturer/model:

BRIDGESTONE/BATTLAX
HYPERSPORT S23F

Rear tire:

Size:

180/55ZR17M/C (73W)

Manufacturer/model:

BRIDGESTONE/BATTLAX
HYPERSPORT S23R

FRONT and REAR:

Tire air valve:

TR412

Valve core:

#9100 (original)



EWA10601

This motorcycle is fitted with super-high-speed tires. Note the following points in order to make the most efficient use of these tires.

- Use only the specified replacement tires. Other tires may run the danger of bursting at super high speeds.
- Brand-new tires can have a relatively poor grip on certain road surfaces until they have been “broken in”. Therefore, it is advisable before doing any high-speed riding to ride conservatively for approximately 100 km (60 mi) after installing a new tire.
- The tires must be warmed up before a high-speed run.
- Always adjust the tire air pressure according to the operating conditions.

EAU21963

Cast wheels

To maximize the performance, durability, and safe operation of your vehicle, note the following points regarding the specified wheels.

- The wheel rims should be checked for cracks, bends, warp-age or other damage before each ride. If any damage is found, have a Yamaha dealer replace the wheel. Do not attempt even the smallest repair to the wheel. A deformed or cracked wheel must be replaced.
- The wheel should be balanced whenever either the tire or wheel has been changed or replaced. An unbalanced wheel can result in poor performance, adverse handling characteristics, and a shortened tire life.

Periodic maintenance and adjustment

Adjusting the clutch lever free play EAU55645

Measure the clutch lever free play as shown.

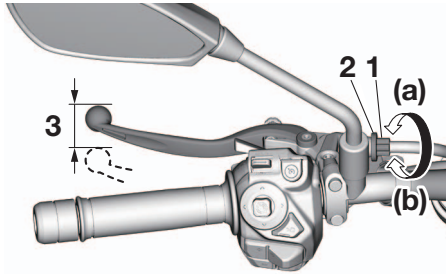

1. Clutch lever free play adjusting bolt
2. Locknut (clutch lever)
3. Clutch lever free play

Clutch lever free play:
5.0–10.0 mm (0.20–0.39 in)

Periodically check the clutch lever free play and, if necessary, adjust it as follows.

1. Loosen the locknut at the clutch lever.
2. To increase the clutch lever free play, turn the clutch lever free play adjusting bolt in direction (a). To

decrease the clutch lever free play, turn the adjusting bolt in direction (b).

TIP

If the specified clutch lever free play could be obtained as described above, skip steps 3–6.

3. Fully turn the adjusting bolt at the clutch lever in direction (a) to loosen the clutch cable.
4. Loosen the locknut at the crankcase.

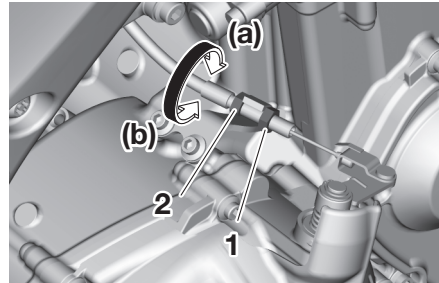

1. Locknut (crankcase)
2. Clutch lever free play adjusting nut

5. To increase the clutch lever free play, turn the clutch lever free play adjusting nut in direction (a). To

decrease the clutch lever free play, turn the adjusting nut in direction (b).

6. Tighten the locknut at the crankcase.
7. Tighten the locknut at the clutch lever.

Periodic maintenance and adjustment

Checking the brake lever free play

EAU37914

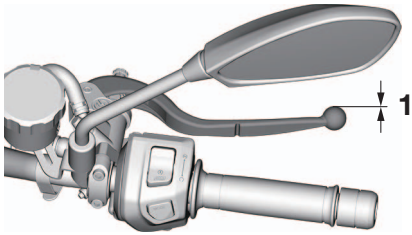

1. No brake lever free play

There should be no free play at the brake lever end. If there is free play, have a Yamaha dealer inspect the brake system.

EWA14212

WARNING

A soft or spongy feeling in the brake lever can indicate the presence of air in the hydraulic system. If there is air in the hydraulic system, have a Yamaha dealer bleed the system before operating the vehicle. Air in the hydraulic system will diminish the

braking performance, which may result in loss of control and an accident.

Brake light switches

EAU36505

The brake light should come on just before braking takes effect. The brake light is activated by switches connected to the brake lever and brake pedal. Since the brake light switches are components of the anti-lock brake system, they should only be serviced by a Yamaha dealer.

Checking the front and rear brake pads

EAU22393

The front and rear brake pads must be checked for wear at the intervals specified in the periodic maintenance and lubrication chart.

Front brake pads

EAU36892

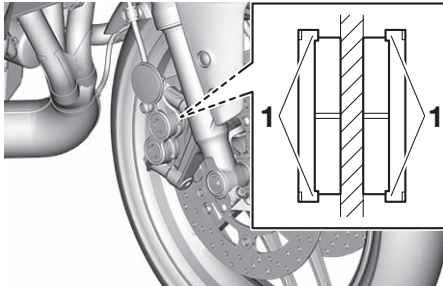

1. Brake pad wear indicator

Each front brake pad is provided with wear indicators, which allows you to check the brake pad wear without having to disassemble the brake. To check the brake pad wear, check the position of the wear indicators while applying the brake. If a brake pad has worn to the point that a wear indicator almost

touches the brake disc, have a Yamaha dealer replace the brake pads as a set.

Rear brake pads

EAU46292

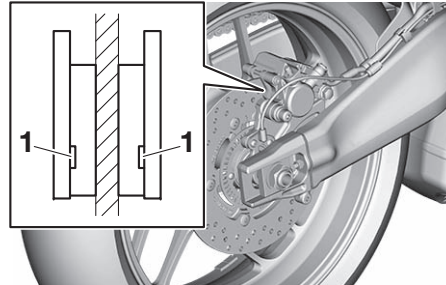

1. Brake pad wear indicator groove

Each rear brake pad is provided with wear indicator grooves, which allow you to check the brake pad wear without having to disassemble the brake. To check the brake pad wear, check the wear indicator grooves. If a brake pad has worn to the point that a wear indicator groove almost appears, have a Yamaha dealer replace the brake pads as a set.

Checking the brake fluid level

EAU40262

Before riding, check that the brake fluid is above the minimum level mark. Check the brake fluid level with the top of the reservoir level. Replenish the brake fluid if necessary.

Front brake

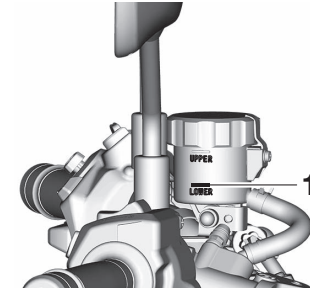

1. Minimum level mark

Periodic maintenance and adjustment

Rear brake

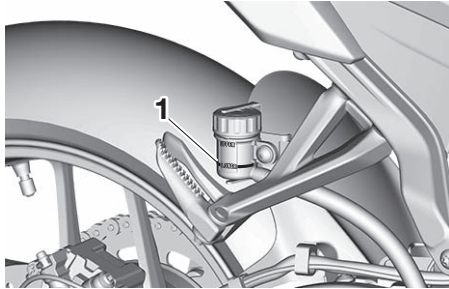

1. Minimum level mark

Specified brake fluid:
DOT 4

EWA16011

WARNING

Improper maintenance can result in loss of braking ability. Observe these precautions:

- **Insufficient brake fluid may allow air to enter the brake system, reducing braking performance.**
- **Clean the filler cap before removing. Use only DOT 4 brake fluid from a sealed container.**

- **Use only the specified brake fluid; otherwise, the rubber seals may deteriorate, causing leakage.**
- **Refill with the same type of brake fluid. Adding a brake fluid other than DOT 4 may result in a harmful chemical reaction.**
- **Be careful that water or dust does not enter the brake fluid reservoir when refilling. Water will significantly lower the boiling point of the fluid and may result in vapor lock, and dirt may clog the ABS hydraulic unit valves.**

fluid level goes down suddenly, have a Yamaha dealer check the cause before further riding.

ECA17641

NOTICE

Brake fluid may damage painted surfaces or plastic parts. Always clean up spilled fluid immediately.

As the brake pads wear, it is normal for the brake fluid level to gradually go down. A low brake fluid level may indicate worn brake pads and/or brake system leakage; therefore, be sure to check the brake pads for wear and the brake system for leakage. If the brake

Changing the brake fluid

EAU22734

Have a Yamaha dealer change the brake fluid every 2 years. In addition, have the seals of the master cylinders and brake calipers, as well as the brake hoses replaced at the intervals listed below or sooner if they are damaged or leaking.

- Brake seals: every 2 years
- Brake hoses: every 4 years

Drive chain slack

EAU22762

The drive chain slack should be checked before each ride and adjusted if necessary.

To check the drive chain slack

EAU91552

1. Place the motorcycle on the side-stand.

TIP _____

When checking and adjusting the drive chain slack, there should be no weight on the motorcycle.

2. Shift the transmission into the neutral position.
3. Find the center point of the chain (position B) by measuring (approx. 32 mm (1.26 in)) forward from the edge of the drive chain guard as shown.

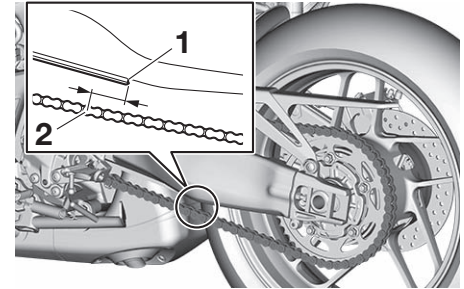

1. Edge of the drive chain guard
2. Position B

4. Push down on the center of the drive chain and measure the distance A from the drive chain guard to the middle of the chain link being pressed down at position B.

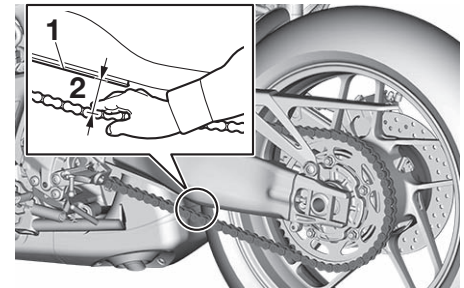

1. Drive chain guard
2. Distance A

Periodic maintenance and adjustment

Distance A:

36.0–41.0 mm (1.42–1.61 in)

5. If distance A is incorrect, adjust it as follows. **NOTICE: Improper drive chain slack will overload the engine as well as other vital parts of the motorcycle and can lead to chain slippage or breakage. If distance A is more than 46.0 mm (1.81 in), the chain can damage the frame, swingarm, and other parts. To prevent this from occurring, keep the drive chain slack within the specified limits.** [ECA23070]

EAU74260

9 To adjust the drive chain slack

Consult a Yamaha dealer before adjusting the drive chain slack.

1. Loosen the axle nut and the locknut on each side of the swingarm.

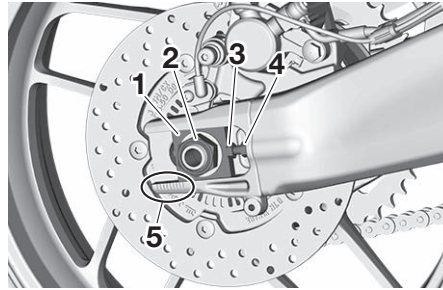

1. Drive chain puller
2. Axle nut
3. Drive chain slack adjusting bolt
4. Locknut
5. Alignment marks

2. To tighten the drive chain, turn the drive chain slack adjusting bolt on each side of the swingarm in direction (a). To loosen the drive chain, turn the adjusting bolt on each side of the swingarm in direction (b), and then push the rear wheel forward.

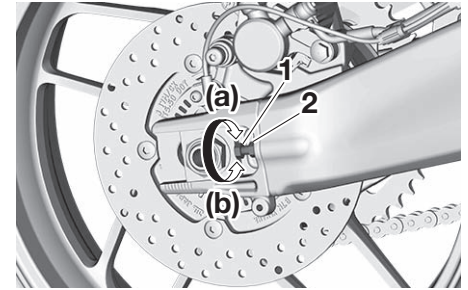

1. Drive chain slack adjusting bolt
2. Locknut

TIP

Using the alignment marks on each side of the swingarm, make sure that both drive chain pullers are in the same position for proper wheel alignment.

3. Tighten the axle nut, then the locknuts to their specified torques.

Tightening torques:

Axle nut:

105 N·m (10.5 kgf·m, 77 lb·ft)

Locknut:

16 N·m (1.6 kgf·m, 12 lb·ft)

4. Make sure that the drive chain pullers are in the same position, the drive chain slack is correct, and the drive chain moves smoothly.

Cleaning and lubricating the drive chain

EAU23027

The drive chain must be cleaned and lubricated at the intervals specified in the periodic maintenance and lubrication chart, otherwise it will quickly wear out, especially when riding in dusty or wet areas. Service the drive chain as follows.

ECA10584

NOTICE

The drive chain must be lubricated after washing the motorcycle, riding in the rain or riding in wet areas.

1. Clean the drive chain with a drive chain cleaner and a small soft brush. **NOTICE: To prevent damaging the O-rings, do not clean the drive chain with steam cleaners, high-pressure washers or inappropriate solvents.**

[ECA11122]

2. Wipe the drive chain dry.
3. Thoroughly lubricate the drive chain with a special O-ring chain lubricant. **NOTICE: Do not use engine oil or any other lubri-**

cants for the drive chain, as they may contain substances that could damage the O-rings.

[ECA11112]

Periodic maintenance and adjustment

Checking and lubricating the cables

EAU23098

The operation of all control cables and the condition of the cables should be checked before each ride, and the cables and cable ends should be lubricated if necessary. If a cable is damaged or does not move smoothly, have a Yamaha dealer check or replace it. **WARNING! Damage to the outer housing of cables may result in internal rusting and cause interference with cable movement. Replace damaged cables as soon as possible to prevent unsafe conditions.** [EWA10712]

Recommended lubricant:

Yamaha cable lubricant or other suitable cable lubricant

Checking and lubricating the throttle grip

EAU82490

The operation of the throttle grip should be checked before each ride. In addition, the throttle grip housing should be lubricated by a Yamaha dealer at the intervals specified in the periodic maintenance chart.

Checking and lubricating the brake and shift pedals

EAU44276

The operation of the brake and shift pedals should be checked before each ride, and the pedal pivots should be lubricated if necessary.

Brake pedal

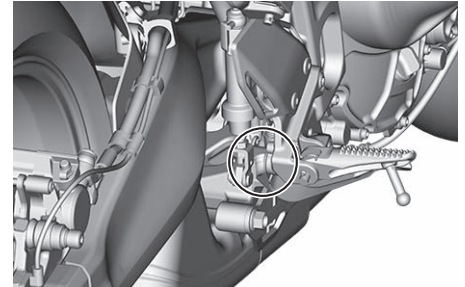

Shift pedal

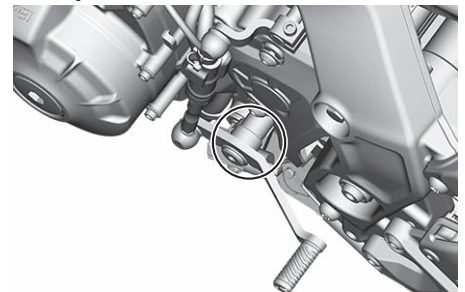

Periodic maintenance and adjustment

Recommended lubricant:
Lithium-soap-based grease

Checking and lubricating the ^{EAU23144}brake and clutch levers

The operation of the brake and clutch levers should be checked before each ride, and the lever pivots should be lubricated if necessary.

Recommended lubricants:
Brake lever:
Silicone grease
Clutch lever:
Lithium-soap-based grease

Brake lever

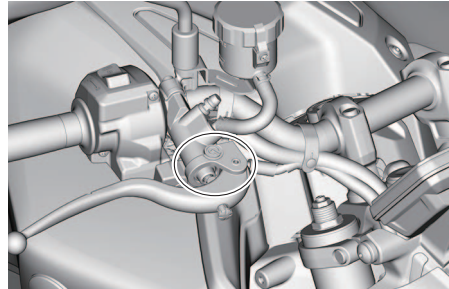

Clutch lever

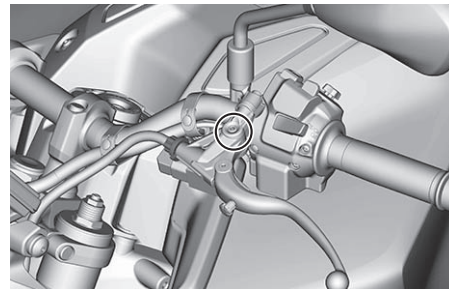

Periodic maintenance and adjustment

Checking and lubricating the sidestand

EAU89101

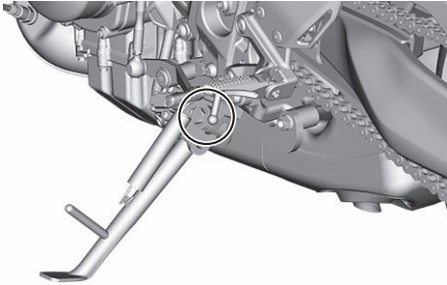

The operation of the sidestand should be checked before each ride, and the sidestand pivot and metal-to-metal contact surfaces should be lubricated if necessary.

EWA10732

WARNING

If the sidestand does not move up and down smoothly, have a Yamaha dealer check or repair it. Otherwise, the sidestand could contact the ground and distract the operator, resulting in a possible loss of control.

Recommended lubricant:
Molybdenum disulfide grease

Lubricating the rear suspension

EAU23252

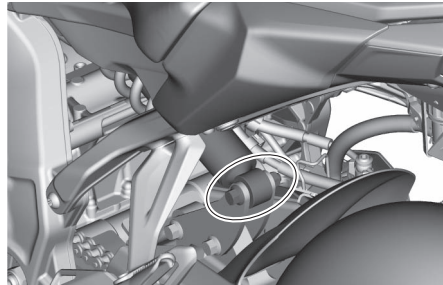

The pivoting points of the rear suspension must be lubricated by a Yamaha dealer at the intervals specified in the periodic maintenance and lubrication chart.

Recommended lubricant:
Lithium-soap-based grease

Lubricating the swingarm pivots

EAUM1653

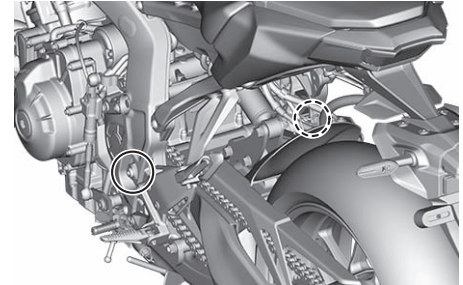

The swingarm pivots must be lubricated by a Yamaha dealer at the intervals specified in the periodic maintenance and lubrication chart.

Recommended lubricant:
Lithium-soap-based grease

EAU23273

Checking the front fork

The condition and operation of the front fork must be checked as follows at the intervals specified in the periodic maintenance and lubrication chart.

To check the condition

Check the inner tubes for scratches, damage and excessive oil leakage.

To check the operation

1. Place the vehicle on a level surface and hold it in an upright position. **WARNING! To avoid injury, securely support the vehicle so there is no danger of it falling over.** [EWA10752]
2. While applying the front brake, push down hard on the handlebars several times to check if the front fork compresses and rebounds smoothly.

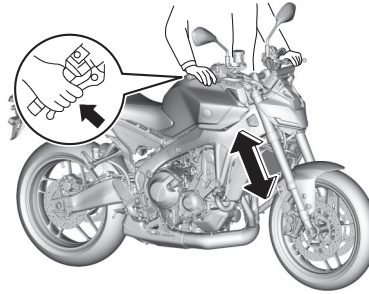

ECA10591

NOTICE

If any damage is found or the front fork does not operate smoothly, have a Yamaha dealer check or repair it.

EAU23285

Checking the steering

Worn or loose steering bearings may cause danger. Therefore, the operation of the steering must be checked as follows at the intervals specified in the periodic maintenance and lubrication chart.

1. Raise the front wheel off the ground. (See page 9-33.) **WARNING! To avoid injury, securely support the vehicle so there is no danger of it falling over.** [EWA10752]
2. Hold the lower ends of the front fork legs and try to move them forward and backward. If any free play can be felt, have a Yamaha dealer check or repair the steering.

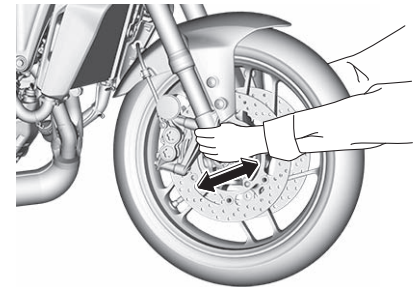

Periodic maintenance and adjustment

Checking the wheel bearings

EAU23292

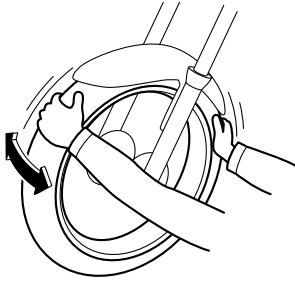

The front and rear wheel bearings must be checked at the intervals specified in the periodic maintenance and lubrication chart. If there is play in the wheel hub or if the wheel does not turn smoothly, have a Yamaha dealer check the wheel bearings.

9

Battery

EAU93320

ECA22960

NOTICE

Use only the specified genuine YAMAHA battery. Using a different battery may cause the IMU to fail and the engine to stall.

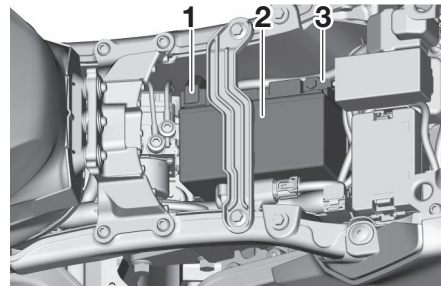

1. Positive battery lead (red)
2. Battery
3. Negative battery lead (black)

The battery is located under the rider seat. (See page 6-41.)

This model is equipped with a VRLA (Valve Regulated Lead Acid) battery. There is no need to check the electrolyte or to add distilled water. However,

the battery lead connections need to be checked and, if necessary, tightened.

EWA10761

! WARNING

- **Electrolyte is poisonous and dangerous since it contains sulfuric acid, which causes severe burns. Avoid any contact with skin, eyes or clothing and always shield your eyes when working near batteries. In case of contact, administer the following FIRST AID.**
 - **EXTERNAL:** Flush with plenty of water.
 - **INTERNAL:** Drink large quantities of water or milk and immediately call a physician.
 - **EYES:** Flush with water for 15 minutes and seek prompt medical attention.
- **Batteries produce explosive hydrogen gas. Therefore, keep sparks, flames, cigarettes, etc., away from the battery and provide sufficient ventilation when charging it in an enclosed space.**

Periodic maintenance and adjustment

- **KEEP THIS AND ALL BATTERIES OUT OF THE REACH OF CHILDREN.**

To charge the battery

Have a Yamaha dealer charge the battery as soon as possible if it seems to have discharged. Keep in mind that the battery tends to discharge more quickly if the vehicle is equipped with optional electrical accessories.

ECA16522

NOTICE

To charge a VRLA (Valve Regulated Lead Acid) battery, a special (constant-voltage) battery charger is required. Using a conventional battery charger will damage the battery.

To store the battery

1. If the vehicle will not be used for more than one month, remove the battery, fully charge it, and then place it in a cool, dry place. **NOTICE: When removing the battery, be sure to turn the main**

switch off, then disconnect the negative lead before disconnecting the positive lead. [ECA16304]

2. If the battery will be stored for more than two months, check it at least once a month and fully charge it if necessary.
3. Fully charge the battery before installation. **NOTICE: When installing the battery, be sure to turn the main switch off, then connect the positive lead before connecting the negative lead.**

[ECA16842]

4. After installation, make sure that the battery leads are properly connected to the battery terminals.

ECA16531

NOTICE

Always keep the battery charged. Storing a discharged battery can cause permanent battery damage.

EAUA1841

Replacing the fuses

The fuse box is located under the rider seat. (See page 6-41.)

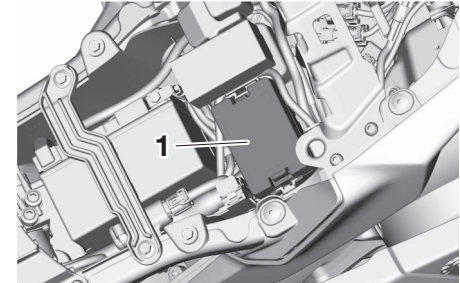

1. Fuse box

Periodic maintenance and adjustment

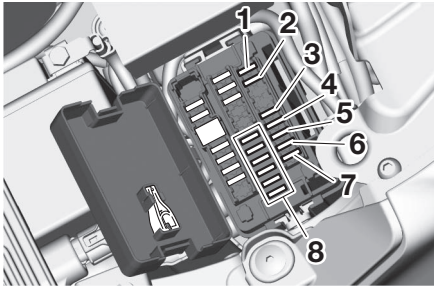

1. Terminal fuse 1
2. Accessory fuse
3. Signaling system fuse
4. Ignition fuse
5. Ignition fuse 2
6. Headlight fuse
7. ABS control unit fuse
8. Spare fuse

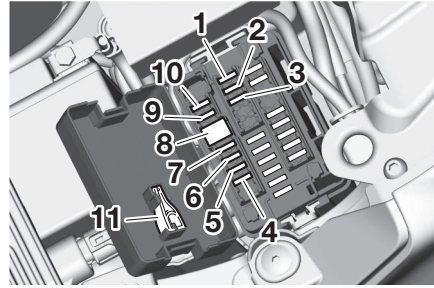

1. Brake light fuse
2. Cruise control fuse
3. Radiator fan motor fuse
4. Electronic throttle valve fuse
5. Fuel injection system fuse
6. Backup fuse 2 (for ECU and immobilizer system)
7. Backup fuse
8. Main fuse
9. ABS motor fuse
10. ABS solenoid fuse
11. Fuse puller

If a fuse is blown, replace it as follows.

TIP

Use a fuse puller to remove the fuse.

1. Turn the main switch off and turn off the electrical circuit in question.

2. Remove the fuse box cover by pressing inwards at the two points indicated on the cover and pulling upwards.

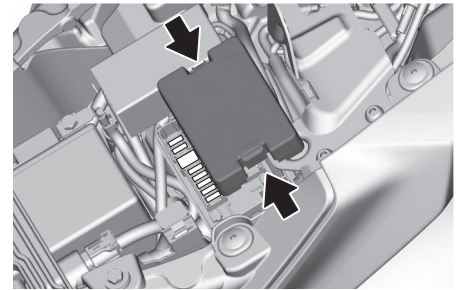

3. Remove the blown fuse using the fuse puller.

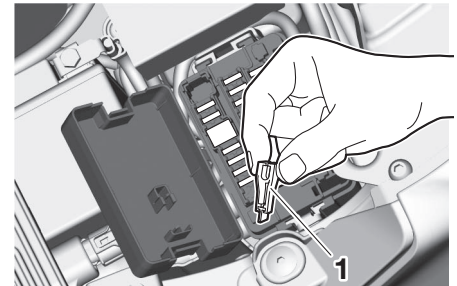

1. Fuse puller

Periodic maintenance and adjustment

4. Install a new fuse of the specified amperage. **WARNING! Do not use a fuse of a higher amperage rating than recommended to avoid causing extensive damage to the electrical system and possibly a fire.** [EWA15132]

Specified fuses:

Main fuse:
50.0 A
Terminal fuse 1:
5.0 A
Headlight fuse:
7.5 A
Brake light fuse:
2.0 A
Signaling system fuse:
7.5 A
Ignition fuse:
10.0 A
Ignition fuse 2:
7.5 A
Radiator fan motor fuse:
15.0 A
ABS motor fuse:
30.0 A
Fuel injection system fuse:
7.5 A
ABS solenoid fuse:
15.0 A
ABS control unit fuse:
7.5 A
Cruise control fuse:
2.0 A
Backup fuse:
7.5 A
Backup fuse 2:
15.0 A
Electronic throttle valve fuse:
7.5 A
Accessory fuse:
2.0 A

5. Insert the fuse puller, and then install the fuse box cover.
6. Turn the main switch on and turn on the electrical circuit in question to check if the device operates.
7. If the fuse immediately blows again, have a Yamaha dealer check the electrical system.

ECA27210

NOTICE

Do not drive while the fuse box cover is removed.

Periodic maintenance and adjustment

Vehicle lights

EAU80380

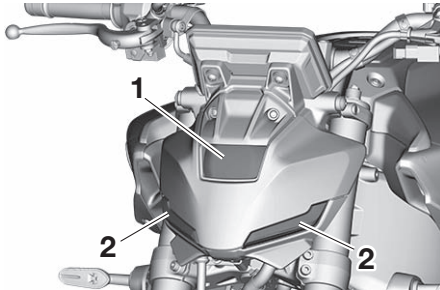

1. Headlight
2. Auxiliary light

Except for the license plate light bulb, this model's lights are all LED.

If an LED light does not come on, check the fuses and then have a Yamaha dealer check the vehicle. If the license plate light does not come on, check and replace the bulb. (See page 9-33.)

ECA16581

NOTICE

Do not affix any type of tinted film or stickers to the headlight lens.

License plate light

EAU24331

If the license plate light does not come on, have a Yamaha dealer check the electrical circuit or replace the bulb.

Supporting the motorcycle

EAU67131

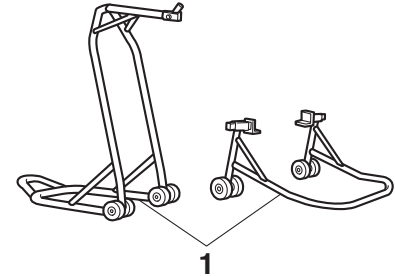

1. Maintenance stand (example)

Since this model is not equipped with a centerstand, use maintenance stands when removing the front or rear wheel or when performing other maintenance that requires the motorcycle to stand up right.

Check that the motorcycle is in a stable and level position before starting any maintenance.

EAU25873

Troubleshooting

Although Yamaha motorcycles receive a thorough inspection before shipment from the factory, trouble may occur during operation. Any problem in the fuel, compression, or ignition systems, for example, can cause poor starting and loss of power.

The following troubleshooting charts represent quick and easy procedures for checking these vital systems yourself. However, should your motorcycle require any repair, take it to a Yamaha dealer, whose skilled technicians have the necessary tools, experience, and know-how to service the motorcycle properly.

Use only genuine Yamaha replacement parts. Imitation parts may look like Yamaha parts, but they are often inferior, have a shorter service life and can lead to expensive repair bills.

EWA15142



WARNING

When checking the fuel system, do not smoke, and make sure there are no open flames or sparks in the area, including pilot lights from water

heaters or furnaces. Gasoline or gasoline vapors can ignite or explode, causing severe injury or property damage.

Periodic maintenance and adjustment

EAU86350

Troubleshooting chart

1. Fuel

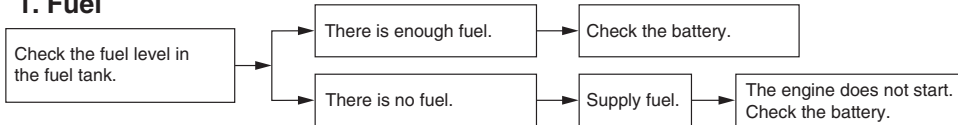

2. Battery

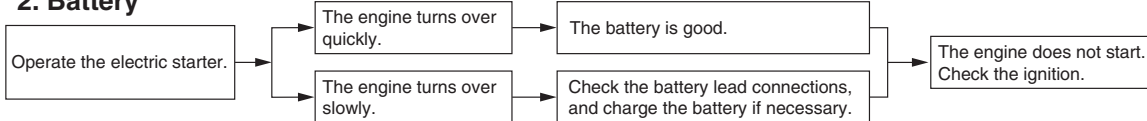

3. Ignition

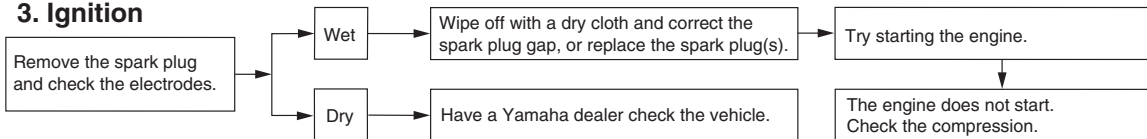

4. Compression

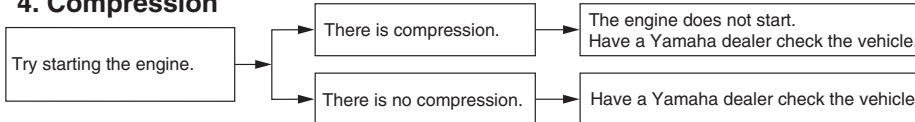

Periodic maintenance and adjustment

EAU86420

Engine overheating

EWAT1041

WARNING

- Do not remove the radiator cap when the engine and radiator are hot. Scalding hot fluid and steam may be blown out under pressure, which could cause serious injury. Be sure to wait until the engine has cooled.
- Place a thick rag, like a towel, over the radiator cap, and then slowly rotate the cap counterclockwise to the detent to allow any residual pressure to escape. When the hissing sound has stopped, press down on the cap while turning it counterclockwise, and then remove the cap.

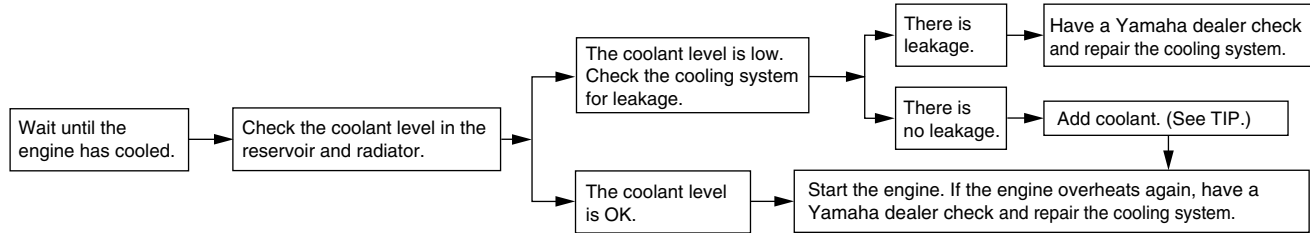

TIP

If coolant is not available, tap water can be temporarily used instead, provided that it is changed to the recommended coolant as soon as possible.

Motorcycle care and storage

Matte color caution

EAU37834

NOTICE

ECA15193

Some models are equipped with matte colored finished parts. Be sure to consult a Yamaha dealer for advice on what products to use before cleaning the vehicle. Using a brush, harsh chemical products or cleaning compounds when cleaning these parts will scratch or damage their surface. Wax also should not be applied to any matte colored finished parts.

Care

EAU83446

Frequent, thorough cleaning of the vehicle will not only enhance its appearance but also will improve its general performance and extend the useful life of many components. Washing, cleaning, and polishing will also give you a chance to inspect the condition of the vehicle more frequently. Be sure to wash the vehicle after riding in the rain or near the sea, because salt is corrosive to metals.

Special care in winter

ECA28181

NOTICE

In cold weather, when roads may be salted as a de-icing method, it's important to clean the vehicle thoroughly to remove road salt and avoid corrosion. Wheel spokes, bolts/nuts and other unpainted metal parts can be especially vulnerable to corrosion from road salt. Apply an anti-corrosion product to any vulnerable parts after washing and drying the vehicle.

TIP

- The roads of heavy snowfall areas may be sprayed with salt as a de-icing method. This salt can stay on the roads well into spring, so be sure to wash the underside and chassis parts after riding in such areas.
 - Genuine Yamaha care and maintenance products are sold under the YAMALUBE brand in many markets worldwide.
 - See your Yamaha dealer for additional cleaning tips.
-

NOTICE

ECA26280

Improper cleaning can cause cosmetic and mechanical damage. Do not use:

- high-pressure washers or steam-jet cleaners. Excessive water pressure may cause water seepage and deterioration of wheel bearings, brakes, transmission seals and electrical devices. Avoid high-pressure

detergent applications such as those available in coin-operated car washers.

- **harsh chemicals, including strong acidic wheel cleaners, especially on spoke or magnesium wheels.**
- **harsh chemicals, abrasive cleaning compounds, or wax on matte-finished parts. Brushes can scratch and damage the matte-finish, use soft sponge or towel only.**
- **towels, sponges, or brushes contaminated with abrasive cleaning products or strong chemicals such as, solvents, gasoline, rust removers, brake fluid, or antifreeze, etc.**

Before washing

1. Park the vehicle out of direct sunlight and allow it to cool. This will help avoid water spots.
2. Make sure all caps, covers, electrical couplers and connectors are tightly installed.
3. Cover the muffler end with a plastic bag and a strong rubber band.

4. Pre-soak stubborn stains like insects or bird droppings with a wet towel for a few minutes.
5. Remove road grime and oil stains with a quality degreasing agent and a plastic-bristle brush or sponge. **NOTICE: Do not use degreasing agent on areas requiring lubrication such as seals, gaskets, and wheel axles. Follow product instructions.**

[ECA26290]

Washing

1. Rinse off any degreaser and spray down the vehicle with a garden hose. Use only enough pressure to do the job. Avoid spraying water directly into the muffler, instrument panel, air inlet, or other inner areas such as underseat storage compartments.
2. Wash the vehicle with a quality automotive-type detergent mixed with cool water and a soft, clean towel or sponge. Use an old toothbrush or plastic-bristle brush for hard-to-reach places. **NOTICE: Use cold water if the vehicle has**

been exposed to salt. Warm water will increase salt's corrosive properties. [ECA26301]

3. For windshield-equipped vehicles: Clean the windshield with a soft towel or sponge dampened with water and a pH neutral detergent. If necessary, use a high-quality windshield cleaner or polish for motorcycles. **NOTICE: Never use any strong chemicals to clean the windshield. Additionally, some cleaning compounds for plastic may scratch the windshield, so be sure to test all cleaning products before general application.** [ECA26310]
4. Rinse off thoroughly with clean water. Be sure to remove all detergent residues, as they can be harmful to plastic parts.

After washing

1. Dry the vehicle with a chamois or absorbent towel, preferably microfiber terrycloth.
2. For drive chain-equipped models: Dry and then lubricate the drive chain to prevent rust.

Motorcycle care and storage

3. Use a chrome polish to shine chrome, aluminum, and stainless steel parts. Often the thermally induced discoloring of stainless steel exhaust systems can be removed through polishing.
4. Apply a corrosion protection spray on all metal parts including chrome or nickel-plated surfaces. **WARNING! Do not apply silicone or oil spray to seats, hand grips, rubber foot pegs or tire treads. Otherwise these parts will become slippery, which could cause loss of control. Thoroughly clean the surfaces of these parts before operating the vehicle.** [EWA20651]
5. Treat rubber, vinyl, and unpainted plastic parts with a suitable care product.
6. Touch up minor paint damage caused by stones, etc.
7. Wax all painted surfaces using a non-abrasive wax or use a detail spray for motorcycles.
8. When finished cleaning, start the engine and let it idle for several minutes to help dry any remaining moisture.
9. If the headlight lens has fogged up, start the engine and turn on the headlight to help remove the moisture.
10. Let the vehicle dry completely before storing or covering it.

ECA26320

NOTICE

- Do not apply wax to rubber or unpainted plastic parts.
- Do not use abrasive polishing compounds as they will wear away the paint.
- Apply sprays and wax sparingly. Wipe off excess afterwards.

EWA20660

WARNING

Contaminants left on the brakes or tires can cause loss of control.

- Make sure there is no lubricant or wax on the brakes or tires.
- If necessary, wash the tires with warm water and a mild detergent.

- If necessary, clean the brake discs and pads with brake cleaner or acetone.
 - Before riding at higher speeds, test the vehicle's braking performance and cornering behavior.
-

Storage

Always store the vehicle in a cool, dry place. If necessary, protect it against dust with a porous cover. Be sure the engine and the exhaust system are cool before covering the vehicle. If the vehicle often sits for weeks at a time between uses, the use of a quality fuel stabilizer is recommended after each fill-up.

EAU83472

ECA21170

NOTICE

- **Storing the vehicle in a poorly ventilated room or covering it with a tarp, while it is still wet, will allow water and humidity to seep in and cause rust.**
- **To prevent corrosion, avoid damp cellars, stables (because of the presence of ammonia) and areas where strong chemicals are stored.**

Long term storage

Before storing the vehicle long term (60 days or more):

1. Make all necessary repairs and perform any outstanding maintenance.
2. Follow all instructions in the Care section of this chapter.
3. Fill up the fuel tank, adding fuel stabilizer according to product instructions. Run the engine for 5 minutes to distribute treated fuel through the fuel system.
4. For vehicles equipped with a fuel cock: Turn the fuel cock lever to the off position.
5. For vehicles with a carburetor: To prevent fuel deposits from building up, drain the fuel in the carburetor float chamber into a clean container. Retighten the drain bolt and pour the fuel back into the fuel tank.
6. Use a quality engine fogging oil according to product instructions to protect internal engine components from corrosion. If engine fogging oil is not available, perform the following steps for each cylinder:
 - a. Remove the spark plug cap and spark plug.
 - b. Pour a teaspoonful of engine oil into the spark plug bore.
 - c. Install the spark plug cap onto the spark plug, and then place the spark plug on the cylinder head so that the electrodes are grounded. (This will limit sparking during the next step.)
 - d. Turn the engine over several times with the starter. (This will coat the cylinder wall with oil.)
WARNING! To prevent damage or injury from sparking, make sure to ground the spark plug electrodes while turning the engine over.
7. Lubricate all control cables, pivots, levers and pedals, as well as the sidestand and centerstand (if equipped).
8. Check and correct the tire air pressure, and then lift the vehicle so that all wheels are off the ground. Otherwise, turn the

[EWA10952]

Motorcycle care and storage

wheels a little once a month in order to prevent the tires from becoming degraded in one spot.

9. Cover the muffler outlet with a plastic bag to prevent moisture from entering it.
10. Remove the battery and fully charge it, or attach a maintenance charger to keep the battery optimally charged. **NOTICE: Confirm that the battery and its charger are compatible. Do not charge a VRLA battery with a conventional charger.** [ECA26330]

TIP

- If the battery will be removed, charge it once a month and store it in a temperate location between 0-30 °C (32-90 °F).
 - See page 9-29 for more information on charging and storing the battery.
-

Dimensions:

- Overall length:
2090 mm (82.3 in)
- Overall width:
820 mm (32.3 in)
- Overall height:
1145 mm (45.1 in)
- Seat height:
825 mm (32.5 in)
- Wheelbase:
1430 mm (56.3 in)
- Ground clearance:
140 mm (5.51 in)
- Minimum turning radius:
3.0 m (9.84 ft)

Weight:

- Curb weight:
193 kg (425 lb)

Engine:

- Combustion cycle:
4-stroke
- Cooling system:
Liquid cooled
- Valve train:
DOHC
- Cylinder arrangement:
Inline
- Number of cylinders:
3-cylinder
- Displacement:
890 cm³
- Bore × stroke:
78.0 × 62.1 mm (3.07 × 2.44 in)

- Starting system:
Electric starter

Engine oil:

- Recommended brand:



- SAE viscosity grades:
10W-40
- Recommended engine oil grade:
API service SG type or higher, JASO standard MA
- Engine oil quantity:
Oil change:
2.80 L (2.96 US qt, 2.46 Imp.qt)
With oil filter removal:
3.20 L (3.38 US qt, 2.82 Imp.qt)

Coolant quantity:

- Coolant reservoir (up to the maximum level mark):
0.28 L (0.30 US qt, 0.25 Imp.qt)
- Radiator (including all routes):
1.72 L (1.82 US qt, 1.51 Imp.qt)

Fuel:

- Recommended fuel:
Unleaded gasoline (E10 acceptable)
- Octane number (RON):
95
- Fuel tank capacity:
14 L (3.7 US gal, 3.1 Imp.gal)
- Fuel reserve amount:
2.5 L (0.66 US gal, 0.55 Imp.gal)

Fuel injection:

- Throttle body:
ID mark:
BME1

Drivetrain:

- Gear ratio:
1st:
2.571 (36/14)
2nd:
1.947 (37/19)
3rd:
1.619 (34/21)
4th:
1.381 (29/21)
5th:
1.190 (25/21)
6th:
1.037 (28/27)

Front tire:

- Type:
Tubeless
- Size:
120/70ZR17M/C (58W)
- Manufacturer/model:
BRIDGESTONE/BATTLAX HYPERSPORT S23F

Rear tire:

- Type:
Tubeless
- Size:
180/55ZR17M/C (73W)
- Manufacturer/model:
BRIDGESTONE/BATTLAX HYPERSPORT S23R

Specifications

Loading:

Maximum load:

168 kg (372 lb)

(Total weight of rider, passenger, cargo and accessories)

Auxiliary light:

LED

License plate light:

5.0 W

Front brake:

Type:

Hydraulic dual disc brake

Rear brake:

Type:

Hydraulic single disc brake

Front suspension:

Type:

Telescopic fork

Rear suspension:

Type:

Swingarm (link suspension)

Electrical system:

System voltage:

12 V

Battery:

Model:

YTZ10S

Voltage, capacity:

12 V, 8.6 Ah (10 HR)

Bulb wattage:

Headlight:

LED

Brake/tail light:

LED

Front turn signal light:

LED

Rear turn signal light:

LED

Identification numbers

EAU53562

Record the vehicle identification number, engine serial number, and the model label information in the spaces provided below. These identification numbers are needed when registering the vehicle with the authorities in your area and when ordering spare parts from a Yamaha dealer.

VEHICLE IDENTIFICATION NUMBER:

ENGINE SERIAL NUMBER:

MODEL LABEL INFORMATION:

Vehicle identification number

EAU26401

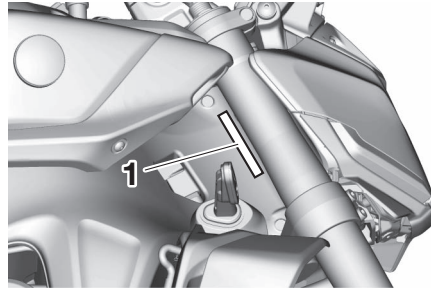

1. Vehicle identification number

The vehicle identification number is stamped into the steering head pipe. Record this number in the space provided.

TIP

The vehicle identification number is used to identify your motorcycle and may be used to register your motorcycle with the licensing authority in your area.

Engine serial number

EAU26442

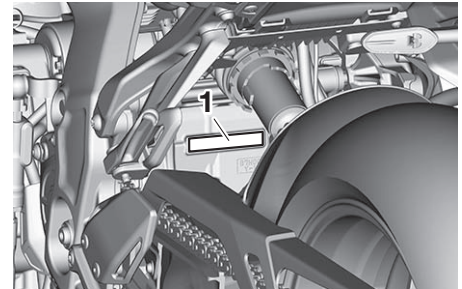

1. Engine serial number

The engine serial number is stamped into the crankcase.

Model label

EAU26471

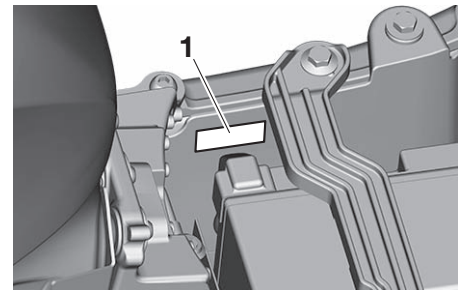

1. Model label

Consumer information

The model label is affixed to the frame under the rider seat. (See page 6-41.) Record the information on this label in the space provided. This information will be needed when ordering spare parts from a Yamaha dealer.

Diagnostic connector

EAU69910

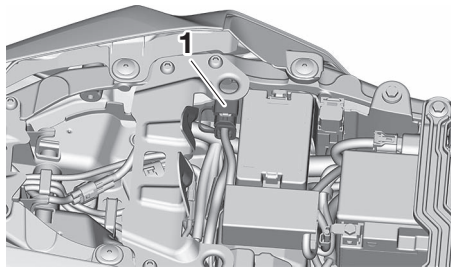

1. Diagnostic connector

The diagnostic connector is located as shown.

Use of your data

What vehicle data we collect and how we collect your vehicle data?

This vehicle collects three types of vehicle data through integrated Engine Control Units (ECU):

- (1) Vehicle Identification Number (VIN);
- (2) live data showing the performance of the vehicle such as engine/motor operating state, vehicle speed, mileage; and
- (3) other data showing the status of the vehicle such as diagnostic trouble code(s) (DTC).

This is done by attaching a special Yamaha diagnostic tool to the vehicle, in circumstances where maintenance checks or service procedures are performed.

This may also be done by connecting to the Yamaha Y-Connect smart phone application and using the application in accordance with the specified terms and conditions.

How and why we use your vehicle data?

Yamaha Motor Australia Pty Limited and/or Yamaha Motor New Zealand Limited (Collectively known as “Yamaha”) uses collected data from your vehicle to;

- (1) conduct adequate maintenance service including diagnostics;
- (2) implement proper warranty claim judgement;
- (3) conduct research and development of vehicle(s);
- (4) provide and improve quality of products, features, and services; and
- (5) comply with the requirements of applicable laws and regulations.

How do we handle your vehicle information?

We may make your vehicle data available to:

- (i) our subsidiaries, controlling entity, other companies within the Yamaha group, affiliates, and business partners;
- (ii) government, statutory or regulatory bodies and law enforcement bodies;
- (iii) dealers in your country or region; and
- (iv) contractors within the scope necessary to achieve the purpose of use described (above).

Consumer information

Overseas Disclosure

Sometimes, we need to provide your information to, or get information about you from, persons located overseas. The countries we usually disclose your personal information to (outside of Australia and New Zealand) include India, Japan, Singapore, Philippines, United States of America, United Kingdom, Germany and France.

How long will we retain your vehicle data?

We will retain your vehicle data for the shortest period of time possible/the time necessary to achieve the purposes listed (above).

CONTACT US AND OPTING OUT

If you would like more information about Yamaha's approach to privacy, contact **1300 593 600 (AUS)** or **0800 926 242 (NZ)**, email corporate.services@yamaha-motor.com.au or review the applicable Privacy Policy located at the following Yamaha websites:

- Australia: <https://www.yamaha-motor.com.au/privacy/policies/yamaha-motor-australia-privacy-policy>
- New Zealand: <https://www.yamaha-motor.co.nz/privacy/policies/yamaha-motor-newzealand-privacy-policy>

EAU26571

Motorcycle noise regulation (for Australia)

TAMPERING WITH NOISE CONTROL SYSTEM PROHIBITED:

Owners are warned that the law may prohibit:

- a. The removal or rendering inoperative by any person other than for purposes of maintenance, repair or replacement, of any device or element of design incorporated into any new vehicle for the purpose of noise control prior to its sale or delivery to the ultimate purchaser or while it is in use; and
- b. The use of the vehicle after such device or element of design has been removed or rendered inoperative by any person.

Index

- A**
ABS warning light 6-6
Air filter element 9-14
Anti-lock brake system (ABS) 6-37
- B**
Battery 9-29
BC (Brake control system) 4-3
Brake and clutch levers, checking
and lubricating 9-26
Brake and shift pedals, checking and
lubricating 9-25
Brake fluid, changing 9-22
Brake fluid level, checking 9-20
Brake lever 6-36
Brake lever free play, checking 9-19
Brake light switches 9-19
Brake pedal 6-37
Brake system 6-37
BSR (Back slip regulator) 4-4
- C**
Cables, checking and lubricating 9-25
Canister 9-10
Care 10-1
Catalytic converter 6-41
Clutch lever 6-35
Clutch lever free play, adjusting 9-18
Connection troubleshooting 5-8
Coolant 9-13
Cruise control switches 6-5
Cruise control system 4-5
- D**
DC connectors 6-48
Diagnostic connector 12-2
Dimmer/Pass switch 6-3
- Display 6-8
Display, menu system 6-17
Drive chain, cleaning and lubricating ... 9-24
Drive chain slack 9-22
- E**
Engine break-in 8-1
Engine idling speed, checking 9-14
Engine oil 9-10
Engine overheating 9-36
Engine serial number 12-1
Engine trouble warning light 6-6
ESS (emergency stop signaling)
system 4-8
- F**
Front and rear brake pads, checking ... 9-20
Front fork, adjusting 6-44
Front fork, checking 9-28
Fuel 6-39
Fuel consumption, tips for reducing 8-4
Fuel tank cap 6-38
Fuel tank overflow hose 6-40
Fuses, replacing 9-30
- H**
Handlebar position, adjusting 6-43
Handlebar switches 6-3
Hazard switch 6-4
High beam indicator light 6-6
Horn switch 6-4
- I**
Identification numbers 12-1
Ignition circuit cut-off system 6-49
Immobilizer system 6-1
Immobilizer system indicator light 6-6
Indicator lights and warning lights 6-5
- J**
Joystick and home button 6-5
- L**
Labels, location 1-1
License plate light 9-33
LIF (Lift control system) 4-3
- M**
Main switch/steering lock 6-2
Maintenance and lubrication, periodic ... 9-5
Maintenance, emission control
system 9-3
Matte color, caution 10-1
Menu system controls 5-1
Model label 12-1
- N**
Navigation system:
Garmin StreetCross 5-5
Neutral indicator light 6-6
Noise regulation (for Australia) 12-5
- P**
Parking 8-5
Part locations 3-1
PWR (Power delivery mode) 4-1
- Q**
QS (Quick shifter) 4-3
- R**
Rear suspension, lubricating 9-27
Rider footrest position, adjusting 6-42
- S**
Safety information 2-1
SCS (Slide control system) 4-2
SC (Stability control system) 4-1
Seats 6-41
Shift indicator light 6-6

Shifting	8-3	Vehicle identification number	12-1
Shift pedal	6-35	Vehicle lights	9-33
Shock absorber assembly, adjusting ...	6-46	W	
Sidestand	6-49	Wheel bearings, checking	9-29
Sidestand, checking and lubricating	9-27	Wheels	9-17
Smart features: Introduction.....	5-1	Y	
Smart features initial setup.....	5-3	Yamaha Motorcycle Connect app	5-2
Spark plugs, checking	9-9	Yamalube	9-12
Special features.....	4-1	YRC mode switch	6-5
Specifications	11-1	YRC (Yamaha Ride Control).....	4-1
Stability control indicator light.....	6-7		
Starting the engine	8-2		
Steering, checking	9-28		
Stop/Run/Start switch	6-4		
Storage	10-4		
Storage compartment	6-43		
Supporting the motorcycle.....	9-33		
Swingarm pivots, lubricating	9-27		
T			
TCS (Traction control system).....	4-2		
Telephone.....	5-7		
Throttle grip, checking and lubricating.....	9-25		
Tires	9-15		
Tool kit.....	9-2		
Troubleshooting.....	9-34		
Troubleshooting chart	9-35		
Turn signal indicator lights	6-5		
Turn signal switch.....	6-4		
U			
USB Type-C jack.....	6-48		
Use, your vehicle data.....	12-3		
V			
Valve clearance	9-15		



PRINTED IN JAPAN
2024.01-0.3×1 CR (E)